

Moments

Moment of a Force About an Axis

- Two forces of the same size and direction acting at different points *are not equivalent*. They may cause the same **translation**, but they cause different **rotation**.
- DEFINITION: *Moment* – A moment is the tendency of a force to make a body rotate about an axis. It is measured by $F \cdot d$, where d is the distance **perpendicular** to the line of action of the force and through the axis of rotation.

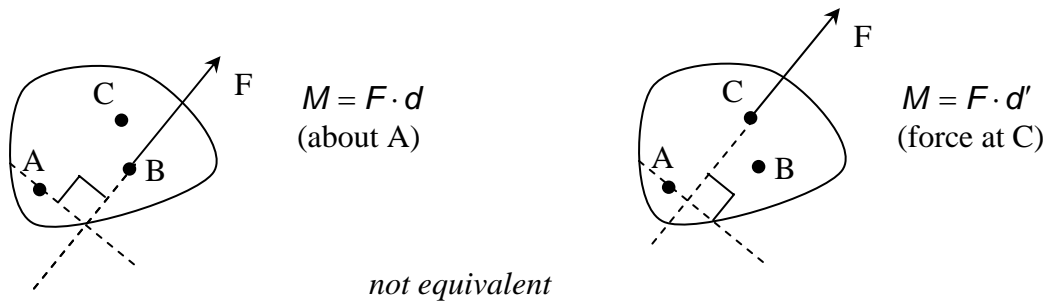

- For the same force, the bigger the **lever arm (or moment arm)**, the bigger the moment magnitude, i.e. $M_A = F \cdot d_1 < M_A = F \cdot d_2$

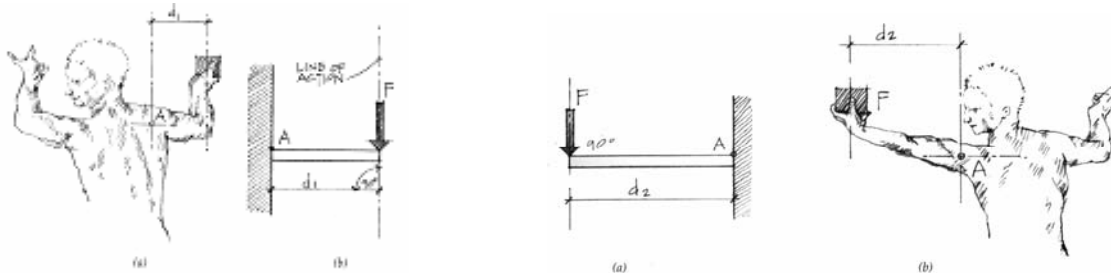

- Units: SI: N·m, KN·m
 Engr. English: lb-ft, kip-ft

- Sign conventions: Moments have magnitude *and* rotational direction:

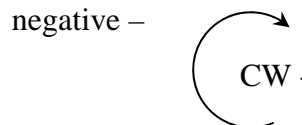
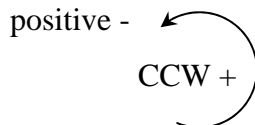

- Moments can be added as scalar quantities when there is a sign convention.

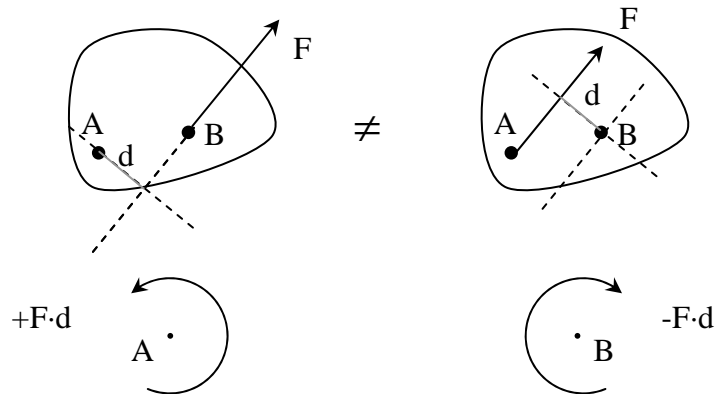

- Repositioning a force along its line of action results in the same moment about any axis.

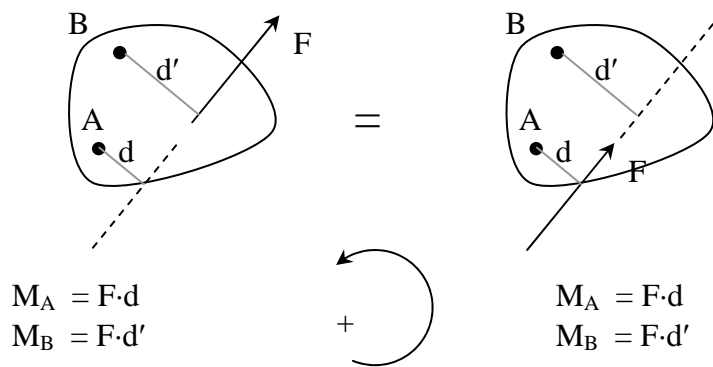

- A force is completely defined (except for its exact position on the line of action) by F_x , F_y , and M_A about A (size and direction).
- The *sign* of the moment is determined by which side of the axis the force is on.

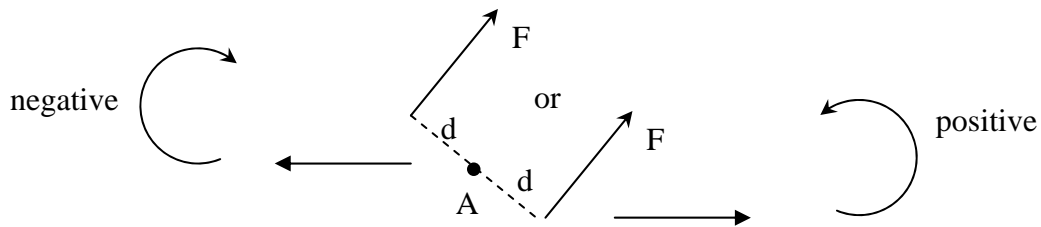

- Varignon's Theorem:* The moment of a force about any axis is equal to the sum of moments of the components about that axis.

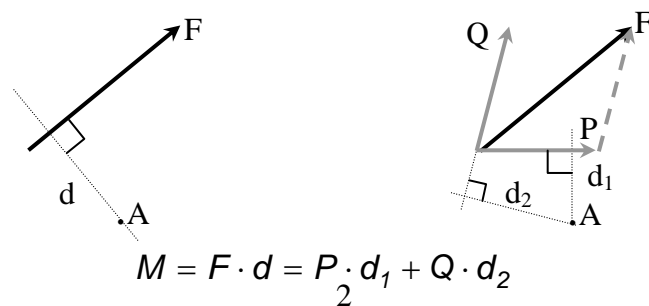

- **Proof 1:** Resolve F into components along line BA and perpendicular to it (90°).

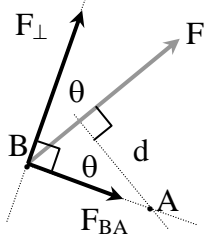

d from A to line $AB = 0$

$$d \text{ from } A \text{ to } F_{\perp} = d_{BA} = \frac{d}{\cos \theta}$$

$$F_{BA} = F \sin \theta$$

$$F_{\perp} = F \cos \theta$$

$$\sum M = -F \cdot d = -F_{BA} \cdot 0 - F_{\perp} \cdot d_{BA} = -F \cos \theta \cdot \frac{d}{\cos \theta} = -F \cdot d$$

- **Proof 2:** Resolve P and Q into P_{BA} & P_{\perp} , and Q_{BA} & Q_{\perp} .

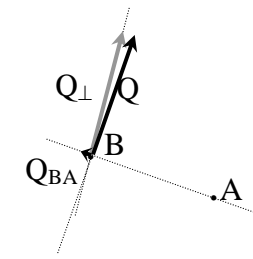
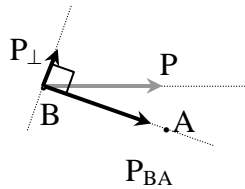
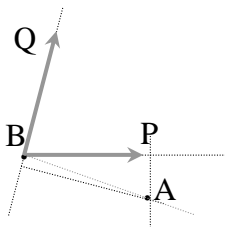

d from A to line $AB = 0$

$$M_{A \text{ by } P} = -P_{\perp} \cdot d_{BA}$$

$$M_{A \text{ by } Q} = -Q_{\perp} \cdot d_{BA}$$

$$\sum M = -P_{\perp} \cdot d_{BA} + (-Q_{\perp} \cdot d_{BA})$$

and we know d_{BA} from Proof 1, and by definition: $P_{\perp} + Q_{\perp} = F_{\perp}$. We know d_{BA} and F_{\perp} from above, so again $M = -F_{\perp} \cdot d_{BA} = -F \cdot d$

- By choosing component directions such that $d = 0$ to one of the components, we can simplify many problems.

Example 1 (pg 24)

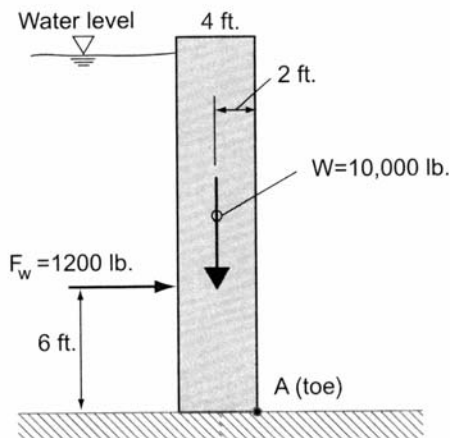

Example Problem 2.13 (Figure 2.35)

A 1-foot-wide slice of a 4-foot-thick concrete gravity dam weighs 10,000 pounds and the equivalent force due to water pressure behind the dam is equal to 1200 pounds. The stability of the dam against overturning is evaluated about the "toe" at A .

Determine the resultant moment at A due to the two forces shown. Is the dam stable?

Example 2
(pg 26)

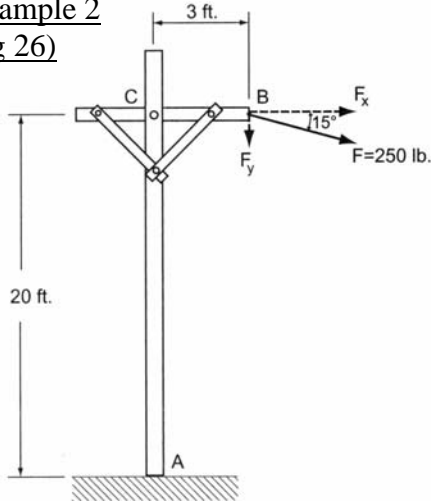

Example Problem 2.15 (Figure 2.38)

The same problem from Example Problem 2.14 will be solved using the principle of moments. (Figure 2.36)
(Moment at A)

Moment Couples

- *Moment Couple*: Two forces with equal magnitude, parallel lines of action and opposite sense tend to make our body rotate even though the sum of forces is 0. The sum of the moment of the forces about any axis *is not zero*.

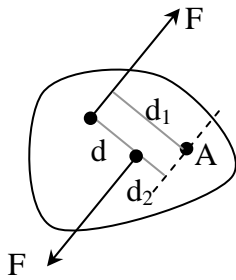

$$\sum M = F \cdot d_2 - F \cdot d_1 = M$$

$$M = F(d_2 - d_1)$$

$$M = -F \cdot d: \text{ moment of the couple (CW)}$$

- M does *not depend on where A is*. M depends on the perpendicular distance between the line of action of the parallel forces.
- M for a couple (defined by F and d) is a constant. And the sense (+/-) is obtained by observation.
- Just as there are equivalent moments (other values of F and d that result in M) there are equivalent couples. The magnitude is the same for different values of F and resulting d or different values of d and resulting F.

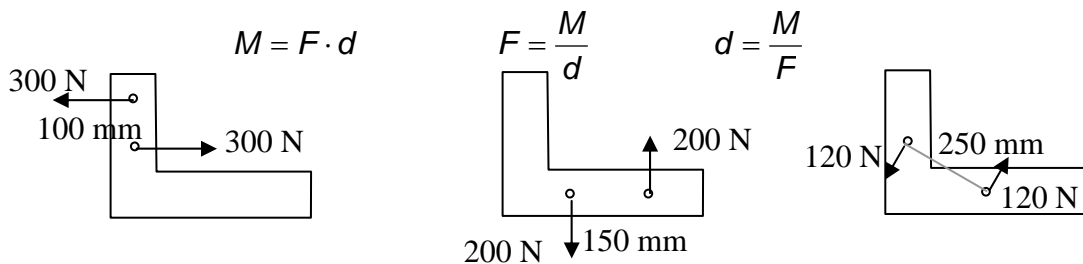

Equivalent Force Systems

- Two systems of forces are equivalent if we can transform one of them into the other with:
 - replacing *two forces on a point* by their **resultant**
 - resolving a *force* into two components
 - canceling two equal and opposite forces on a point
 - attaching two equal and opposite forces to a point
 - moving a force along its line of action'
 - replacing a force and moment on a point with a force on another (specific) point
 - replacing a force on point with a force and moment on another (specific) point

* based on the parallelogram rule and the principle of transmissibility
- The size and direction are important for a moment. The location on a body doesn't matter because couples with the same moment will have the same effect on the rigid body.

Addition of Couples

- Couples can be added as *scalars*.
- Two couples can be *replaced* by a single couple with the magnitude of the algebraic sum of the two couples.

Resolution of a Force into a Force and a Couple

- The equivalent action of a force on a body can be reproduced by that force and a force couple:

If we'd rather have F acting at A' which isn't in the line of action, we can instead add F and $-F$ at A' with no change of action by F . Now it becomes a couple of F separated by d and the force F moved to A' . The size is $F \cdot d = M$

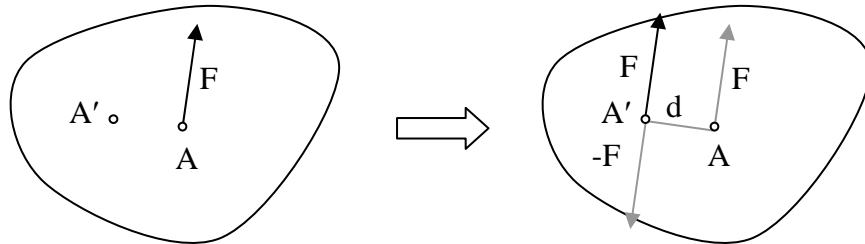

The couple can be represented by a moment symbol:

- Any force can be replaced by itself at another point and the moment equal to the force multiplied by the distance between the original line of action and *new* line of action.

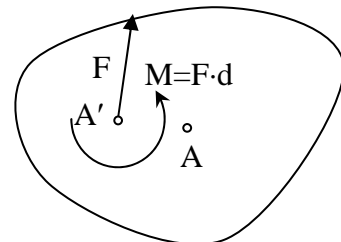

Resolution of a Force into a Force and a Moment

- *Principle:* Any force **F** acting on a rigid body (say the one at A) may be moved to any given point A', provided that a couple **M** is added: the moment **M** of the couple must equal the moment of **F** (in its original position at A) about A'.

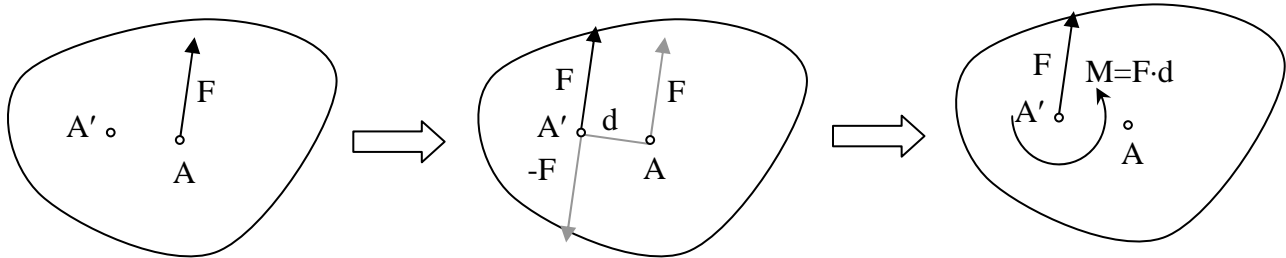

- **IN REVERSE:** A force **F** acting at A' and a couple **M** may be combined into a single resultant force **F** acting at A (a distance *d* away) where the moment of **F** about A' is equal to **M**.

Resultant of Two Parallel Forces

- Gravity loads act in one direction, so we may have parallel forces on our structural elements. We know how to find the resultant **force**, but the *location* of the resultant must provide the equivalent total moment from each individual force.

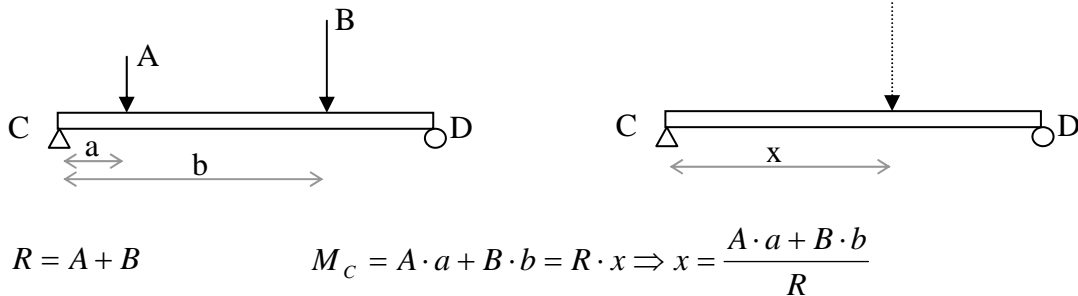

Example 3 (pg 19)

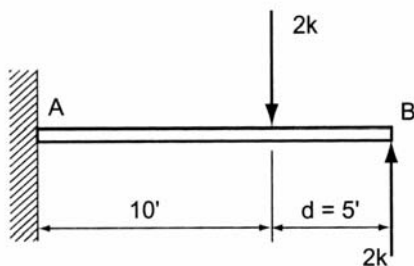

Example Problem 2.19

The cantilevered beam shown in Figure 2.43 is subjected to two equal and opposite forces as shown. Determine the resultant moment M_A at the beam support and the moment M_B at the free end.

Example 4 (pg 34)

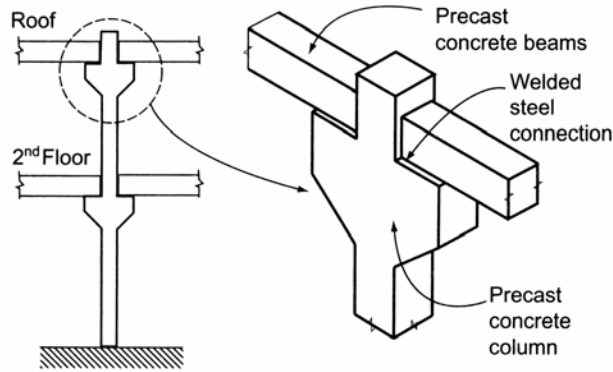

Example Problem 2.22 (Figures 2.49 and 2.50)

A major, precast-concrete column supports beam loads from the roof and second floor as shown. Beams are supported by seats projecting from the columns. Loads from the beams are assumed to be applied one foot from the column axis.

Determine the equivalent column load condition when all beam loads are shown acting through the column axis.

