

lecture
 eighteen

beams:
 deflection & design

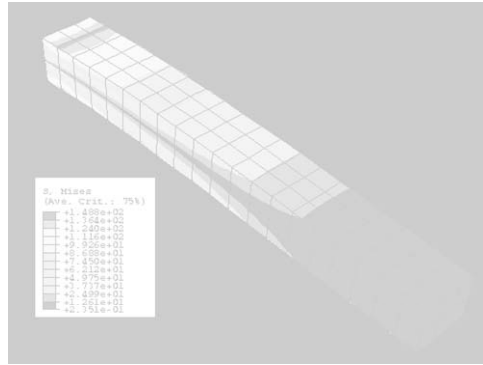

Beam Deflection & Design 1
 Lecture 18

Architectural Structures I
 ENDS 231

Su2004abn

Design for Strength +...

- strength design
 - forces & material
- serviceability
 - limit deflection and cracking
 - control noise & vibration
 - no excessive settlement of foundations
 - durability
 - appearance
 - component damage
 - ponding

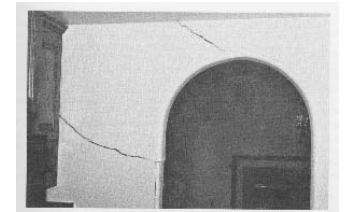
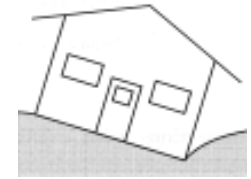

Beam Deflection & Design 4
 Lecture 21

Architectural Structures I
 ENDS 231

S2004abn

Beam Deformations

- curvature relates to
 - bending moment
 - modulus of elasticity
 - moment of inertia

$$\frac{1}{R} = \frac{M}{EI}$$

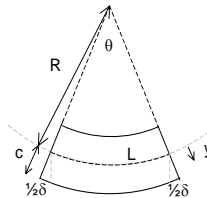

$$\text{curvature} = \frac{M(x)}{EI}$$

$$\theta = \text{slope} = \int \frac{M(x)}{EI} dx$$

$$\Delta = \text{deflection} = \iint \frac{M(x)}{EI} dx$$

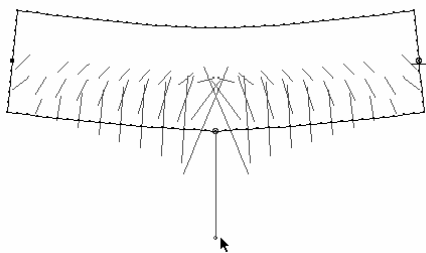

Beam Deflection & Design 5
 Lecture 21

Architectural Structures I
 ENDS 231

S2004abn

Deflected Shape & M(x)

- $-M(x)$ gives shape indication
- boundary conditions must be met

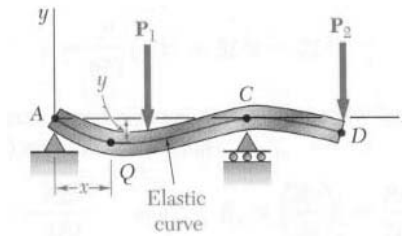
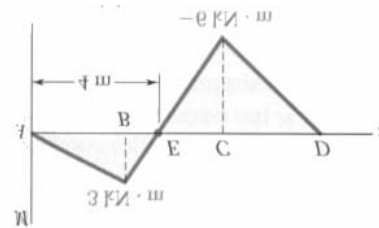

Beam Deflection & Design 6
 Lecture 21

Architectural Structures I
 ENDS 231

S2004abn

Boundary Conditions

- at pins, rollers, fixed supports: $y = 0$
- at fixed supports: $\theta = 0$
- at inflection points from symmetry: $\theta = 0$
- y_{max} at $\frac{dy}{dx} = 0$

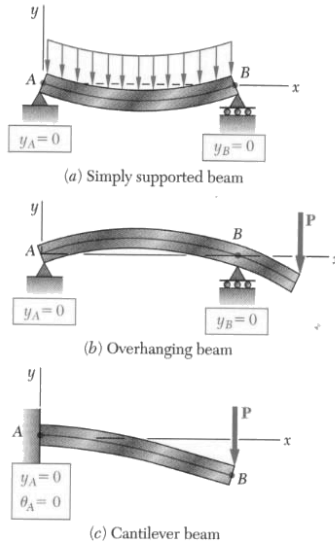

Beam Deflection & Design 7
Lecture 21

Architectural Structures I
ENDS 231

S2004abn

Superpositioning

- if w can be superpositioned
 - θ & y can
 - elastic range only!

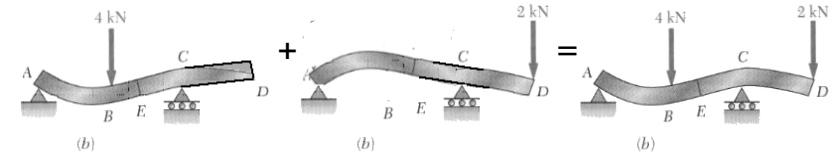

Beam Deflection & Design 8
Lecture 21

Architectural Structures I
ENDS 231

S2004abn

Deflection Limits

- based on service condition, severity

Use	LL only	DL+LL
Roof beams:		
Industrial	L/180	L/120
Commercial		
plaster ceiling	L/240	L/180
no plaster	L/360	L/240
Floor beams:		
Ordinary Usage	L/360	L/240
Roof or floor (damageable elements)		L/480

Beam Deflection & Design 9
Lecture 21

Architectural Structures I
ENDS 231

S2004abn

Lateral Buckling

- lateral buckling caused by compressive forces at top coupled with insufficient rigidity
- can occur at low stress levels
- stiffen, brace or bigger I_y

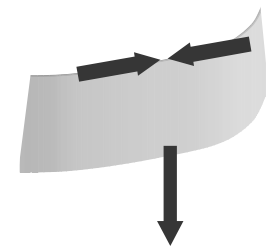
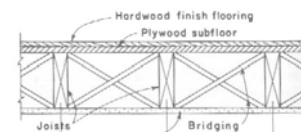

Beam Deflection & Design 10
Lecture 21

Architectural Structures I
ENDS 231

S2004abn

Local Buckling

- steel I beams
- flange
 - buckle in direction of smaller radius of gyration
- web
 - force
 - “crippling”

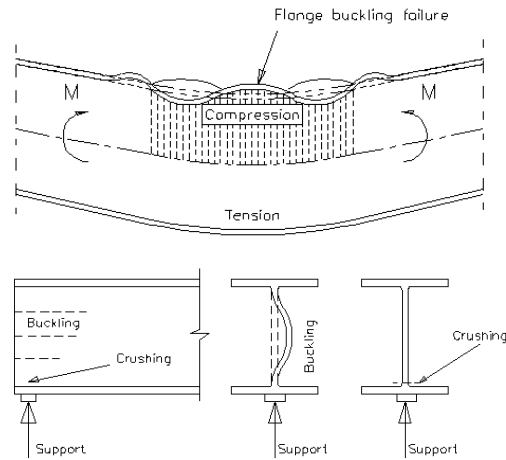

Beam Deflection & Design 11
Lecture 21

Architectural Structures I
ENDS 231

S2004abn

Local Buckling

- flange

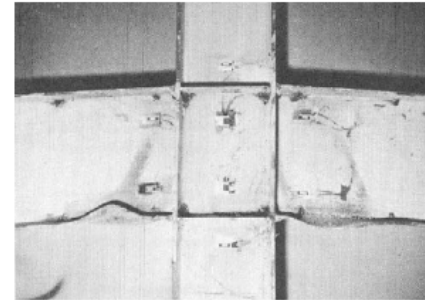

Figure 2-5. Flange Local Bending Limit State (Beedle, L.S., Christopher, R., 1964)

- web



Figure 2-7. Web Local Buckling Limit State (SAC Project)

Beam Deflection & Design 15
Lecture 18

Architectural Structures I
ENDS 231

Su2004abn

Shear in Web

- panels in plate girders or webs with large shear
- buckling in compression direction
- add stiffeners

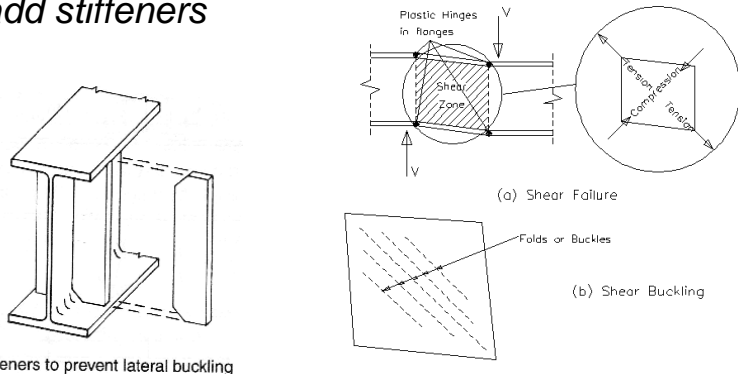

Beam Deflection & Design 12
Lecture 21

Architectural Structures I
ENDS 231

S2004abn

Shear in Web

- plate girders and stiffeners



Beam Deflection & Design 17
Lecture 18

Architectural Structures I
ENDS 231

Su2004abn

Beam Design

1. Know F_{all} for the material or F_U for LRFD

2. Draw V & M , finding M_{max}



3. Calculate $S_{req'd}$ ($f_b \leq F_b$)

$$S = \frac{bh^2}{6}$$

4. Determine section size

Beam Design

4*. Include self weight for M_{max}
– and repeat 3 & 4 if necessary

5. Consider lateral stability

Unbraced roof trusses were blown down in 1999 at this project in Moscow, Idaho.

Photo: Ken Carper



Beam Design

6. Evaluate shear stresses - horizontal

• ($f_v \leq F_v$)
• W and rectangles $f_{v-max} = \frac{3V}{2A} \approx \frac{V}{A_{web}}$

• thin walled sections $f_{v-max} = \frac{VQ}{Ib}$

Beam Design

7. Provide adequate bearing area at supports

$$f_p = \frac{P}{A} \leq F_p$$

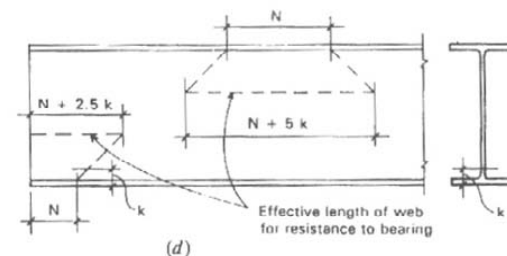

Beam Design

8. Evaluate torsion

$$(f_v \leq F_v)$$

- circular cross section

$$f_v = \frac{T\rho}{J}$$

- rectangular

$$f_v = \frac{T}{c_1 ab^2}$$

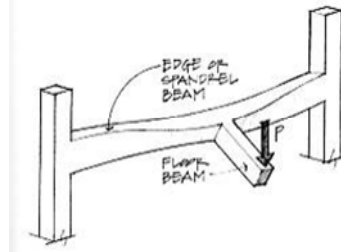
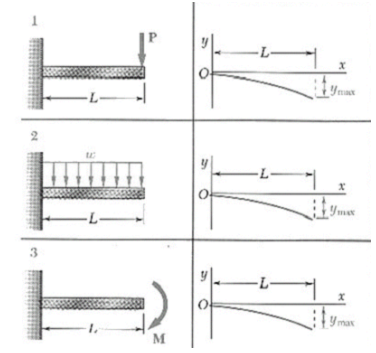
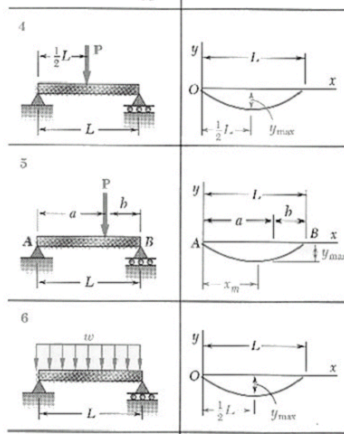

TABLE 3.1. Coefficients for Rectangular Bars in Torsion

b/b	c_1	c_2
1.0	0.208	0.1406
1.2	0.219	0.1661
1.5	0.231	0.1958
2.0	0.246	0.229
2.5	0.258	0.249
3.0	0.267	0.263
4.0	0.282	0.281
5.0	0.291	0.291
10.0	0.312	0.312
∞	0.333	0.333

Beam Design

9. Evaluate deflections



$$y_{\max}(x) = \Delta_{\text{actual}} \leq \Delta_{\text{allowable}}$$

Beam Design

9. – how to read charts

1. SIMPLE BEAM—UNIFORMLY DISTRIBUTED LOAD

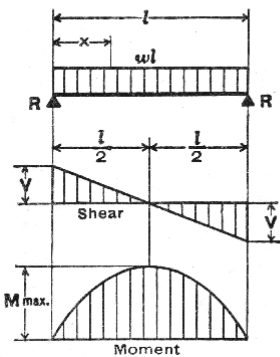

Total Equiv. Uniform Load = wl

$R = V$ = $\frac{wl}{2}$

V_x = $w\left(\frac{l}{2} - x\right)$

$M_{\text{max. (at center)}}$ = $\frac{wl^2}{8}$

M_x = $\frac{wx}{2}(l - x)$

$\Delta_{\text{max. (at center)}}$ = $\frac{5wl^4}{384EI}$

Δ_x = $\frac{wx}{24EI}(l^3 - 2lx^2 + x^3)$