

1. SIMPLE BEAM—UNIFORMLY DISTRIBUTED LOAD

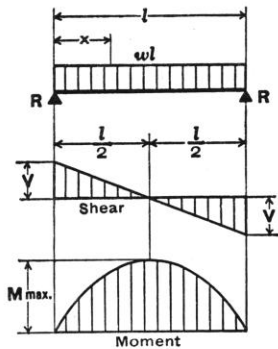

Total Equiv. Uniform Load . . . = wl
 $R = V$ = $\frac{wl}{2}$
 V_x = $w \left(\frac{l}{2} - x \right)$
 $M_{max.}$ (at center) = $\frac{wl^2}{8}$
 M_x = $\frac{wx}{2} (l-x)$
 $\Delta_{max.}$ (at center) = $\frac{5wl^4}{384EI}$
 Δ_x = $\frac{wx}{24EI} (l^3 - 2lx^2 + x^3)$

2. SIMPLE BEAM—LOAD INCREASING UNIFORMLY TO ONE END

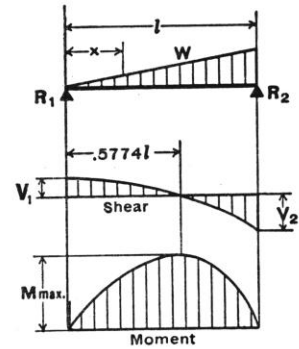

Total Equiv. Uniform Load . . . = $\frac{16W}{9\sqrt{3}} = 1.0264W$
 $R_1 = V_1$ = $\frac{W}{3}$ $W = \frac{wl}{2}$
 $R_2 = V_2$ max. = $\frac{2W}{3}$
 V_x = $\frac{W}{3} - \frac{Wx^2}{l^2}$
 $M_{max.}$ (at $x = \frac{l}{\sqrt{3}} = .5774l$) . . . = $\frac{2Wl}{9\sqrt{3}} = .1283Wl$
 M_x = $\frac{Wx}{3l^2} (l^2 - x^2)$
 $\Delta_{max.}$ (at $x = l\sqrt{1 - \sqrt{\frac{8}{15}}} = .5193l$) = $.01304 \frac{Wl^3}{EI}$
 Δ_x = $\frac{Wx}{180EI l^2} (3x^4 - 10l^2x^2 + 7l^4)$

3. SIMPLE BEAM—LOAD INCREASING UNIFORMLY TO CENTER

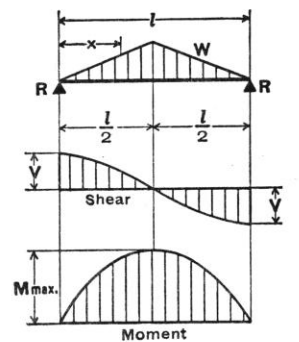

Total Equiv. Uniform Load . . . = $\frac{4W}{3}$ $W = \frac{wl}{2}$
 $R = V$ = $\frac{W}{2}$
 V_x (when $x < \frac{l}{2}$) = $\frac{W}{2l^2} (l^2 - 4x^2)$
 $M_{max.}$ (at center) = $\frac{Wl}{6}$
 M_x (when $x < \frac{l}{2}$) = $Wx \left(\frac{1}{2} - \frac{2x^2}{3l^2} \right)$
 $\Delta_{max.}$ (at center) = $\frac{Wl^3}{60EI}$
 Δ_x (when $x < \frac{l}{2}$) = $\frac{Wx}{480EI l^2} (5l^2 - 4x^2)^2$

4. SIMPLE BEAM—UNIFORM LOAD PARTIALLY DISTRIBUTED

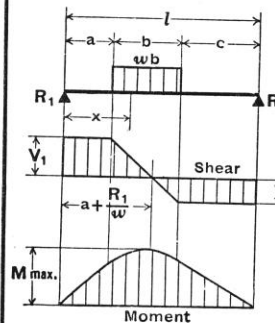

$R_1 = V_1$ (max. when $a < c$) . . . = $\frac{wb}{2l} (2c + b)$
 $R_2 = V_2$ (max. when $a > c$) . . . = $\frac{wb}{2l} (2a + b)$
 V_x (when $x > a$ and $< (a + b)$) . . = $R_1 - w(x - a)$
 $M_{max.}$ (at $x = a + \frac{R_1}{w}$) = $R_1 \left(a + \frac{R_1}{2w} \right)$
 M_x (when $x < a$) = R_1x
 M_x (when $x > a$ and $< (a + b)$) . = $R_1x - \frac{w}{2} (x - a)^2$
 M_x (when $x > (a + b)$) = $R_2(l - x)$

5. SIMPLE BEAM—UNIFORM LOAD PARTIALLY DISTRIBUTED AT ONE END

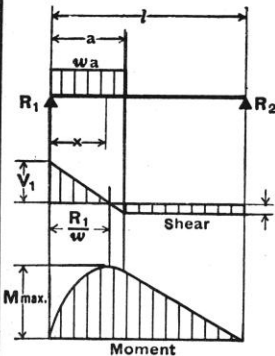

$R_1 = V_1$ max. = $\frac{wa}{2l} (2l - a)$
 $R_2 = V_2$ = $\frac{wa^2}{2l}$
 V_x (when $x < a$) = $R_1 - wx$
 $M_{max.}$ (at $x = \frac{R_1}{w}$) = $\frac{R_1^2}{2w}$
 M_x (when $x < a$) = $R_1x - \frac{wx^2}{2}$
 M_x (when $x > a$) = $R_2(l - x)$
 Δ_x (when $x < a$) = $\frac{wx}{24EI l} (a^2(2l - a)^2 - 2ax^2(2l - a) + lx^3)$
 Δ_x (when $x > a$) = $\frac{wa^2(l - x)}{24EI l} (4xl - 2x^2 - a^2)$

6. SIMPLE BEAM—UNIFORM LOAD PARTIALLY DISTRIBUTED AT EACH END

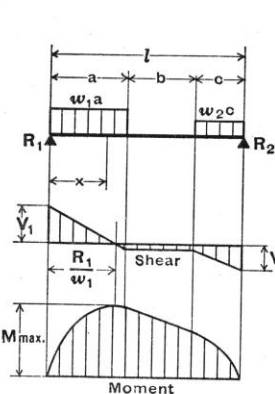

$R_1 = V_1$ = $\frac{w_1a(2l - a) + w_2c^2}{2l}$
 $R_2 = V_2$ = $\frac{w_2c(2l - c) + w_1a^2}{2l}$
 V_x (when $x < a$) = $R_1 - w_1x$
 V_x (when $x > a$ and $< (a + b)$) . . = $R_1 - w_1a$
 V_x (when $x > (a + b)$) = $R_2 - w_2(l - x)$
 $M_{max.}$ (at $x = \frac{R_1}{w_1}$ when $R_1 < w_1a$) . = $\frac{R_1^2}{2w_1}$
 $M_{max.}$ (at $x = l - \frac{R_2}{w_2}$ when $R_2 < w_2c$) = $\frac{R_2^2}{2w_2}$
 M_x (when $x < a$) = $R_1x - \frac{w_1x^2}{2}$
 M_x (when $x > a$ and $< (a + b)$) . = $R_1x - \frac{w_1a}{2} (2x - a)$
 M_x (when $x > (a + b)$) = $R_2(l - x) - \frac{w_2(l - x)^2}{2}$

7. SIMPLE BEAM—CONCENTRATED LOAD AT CENTER

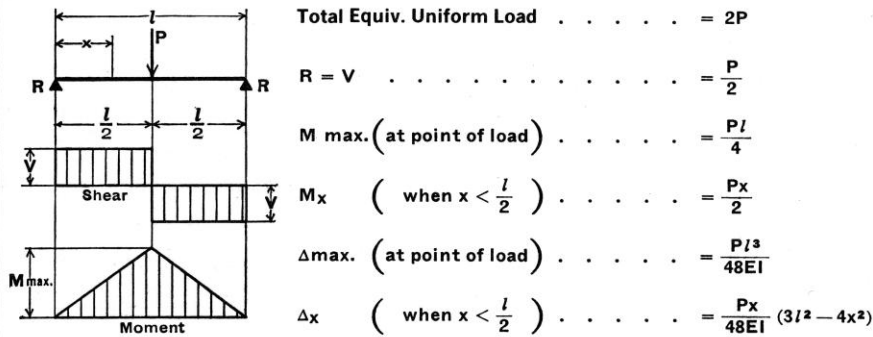

8. SIMPLE BEAM—CONCENTRATED LOAD AT ANY POINT

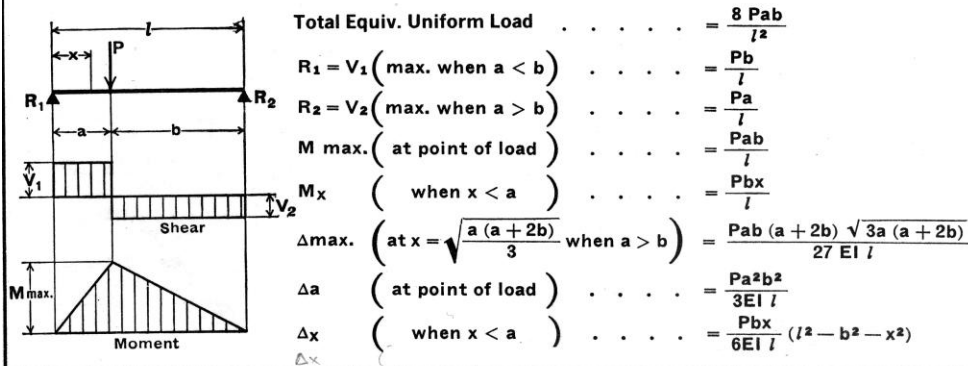

9. SIMPLE BEAM—TWO EQUAL CONCENTRATED LOADS SYMMETRICALLY PLACED

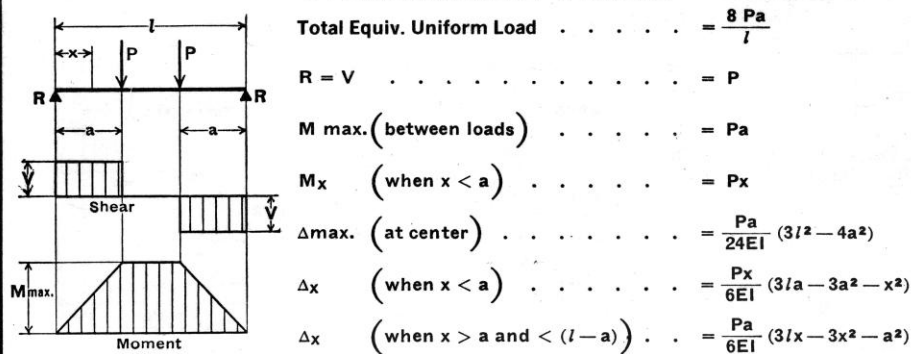

10. SIMPLE BEAM—TWO EQUAL CONCENTRATED LOADS UNSYMMETRICALLY PLACED

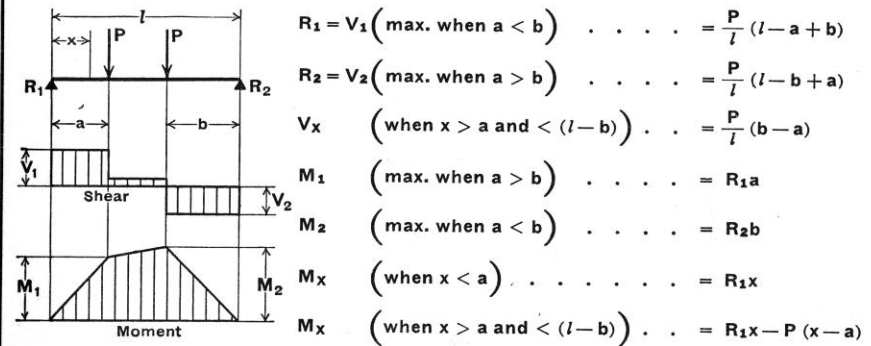

11. SIMPLE BEAM—TWO UNEQUAL CONCENTRATED LOADS UNSYMMETRICALLY PLACED

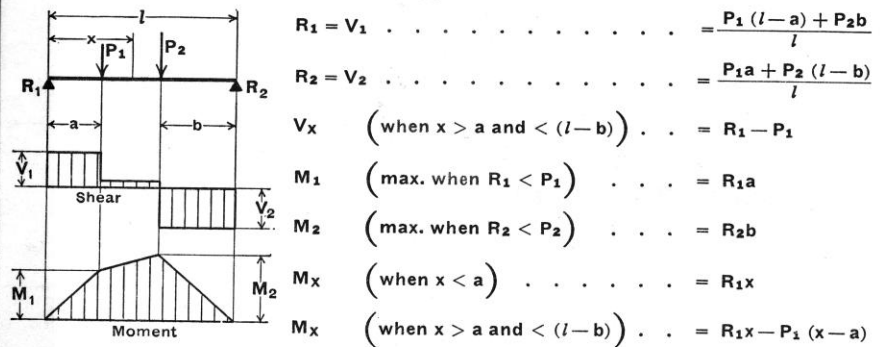

12. BEAM FIXED AT ONE END, SUPPORTED AT OTHER—UNIFORMLY DISTRIBUTED LOAD

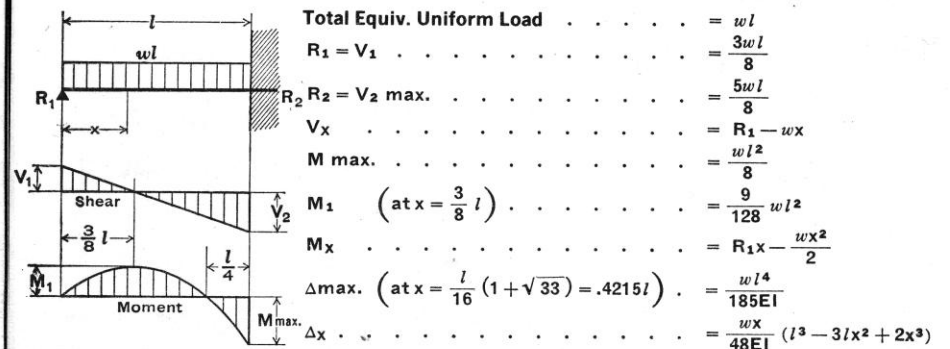

13. BEAM FIXED AT ONE END, SUPPORTED AT OTHER—
CONCENTRATED LOAD AT CENTER

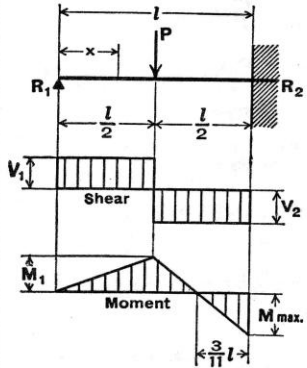

Total Equiv. Uniform Load = $\frac{3P}{2}$
 $R_1 = V_1$ = $\frac{5P}{16}$
 $R_2 = V_2$ max. = $\frac{11P}{16}$
 M max. (at fixed end) = $\frac{3Pl}{16}$
 M_1 (at point of load) = $\frac{5Pl}{32}$
 M_x (when $x < \frac{l}{2}$) = $\frac{5Px}{16}$
 M_x (when $x > \frac{l}{2}$) = $P \left(\frac{l}{2} - \frac{11x}{16} \right)$
 Δ max. (at $x = l \sqrt{\frac{1}{5}} = .4472l$) = $\frac{Pl^3}{48EI \sqrt{5}} = .009317 \frac{Pl^3}{EI}$
 Δ_x (at point of load) = $\frac{7Pl^3}{768EI}$
 Δ_x (when $x < \frac{l}{2}$) = $\frac{Px}{96EI} (3l^2 - 5x^2)$
 Δ_x (when $x > \frac{l}{2}$) = $\frac{P}{96EI} (x-l)^2 (11x - 2l)$

14. BEAM FIXED AT ONE END, SUPPORTED AT OTHER—
CONCENTRATED LOAD AT ANY POINT

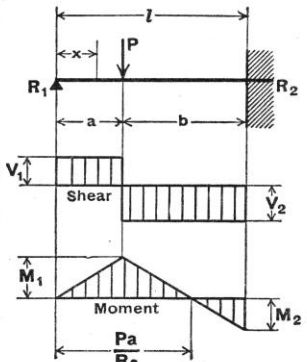

$R_1 = V_1$ = $\frac{Pb^2}{2l^3} (a + 2l)$
 $R_2 = V_2$ = $\frac{Pa}{2l^3} (3l^2 - a^2)$
 M_1 (at point of load) = $R_1 a$
 M_2 (at fixed end) = $\frac{Pab}{2l^2} (a + l)$
 M_x (when $x < a$) = $R_1 x$
 M_x (when $x > a$) = $R_1 x - P(x - a)$
 Δ max. (when $a < .414l$ at $x = l \frac{l^2 + a^2}{3l^2 - a^2}$) = $\frac{Pa}{3EI} \frac{(l^2 - a^2)^3}{(3l^2 - a^2)^2}$
 Δ max. (when $a > .414l$ at $x = l \sqrt{\frac{a}{2l+a}}$) = $\frac{Pa^2}{6EI} \sqrt{\frac{a}{2l+a}}$
 Δa (at point of load) = $\frac{Pa^2 b^3}{12EI l^3} (3l + a)$
 Δ_x (when $x < a$) = $\frac{Pb^2 x}{12EI l^3} (3a l^2 - 2l x^2 - a x^2)$
 Δ_x (when $x > a$) = $\frac{Pa}{12EI l^3} (l-x)^2 (3l^2 x - a^2 x - 2a^2)$

15. BEAM FIXED AT BOTH ENDS—UNIFORMLY DISTRIBUTED
LOADS

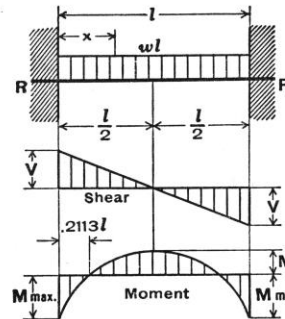

Total Equiv. Uniform Load = $\frac{2wl}{3}$
 $R = V$ = $\frac{wl}{2}$
 V_x = $w \left(\frac{l}{2} - x \right)$
 M max. (at ends) = $\frac{wl^2}{12}$
 M_1 (at center) = $\frac{wl^2}{24}$
 M_x = $\frac{w}{12} (6lx - l^2 - 6x^2)$
 Δ max. (at center) = $\frac{wl^4}{384EI}$
 Δ_x = $\frac{wx^2}{24EI} (l - x)^2$

16. BEAM FIXED AT BOTH ENDS—CONCENTRATED LOAD AT
CENTER

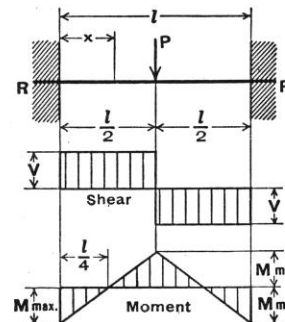

Total Equiv. Uniform Load = P
 $R = V$ = $\frac{P}{2}$
 M max. (at center and ends) = $\frac{Pl}{8}$
 M_x (when $x < \frac{l}{2}$) = $\frac{P}{8} (4x - l)$
 Δ max. (at center) = $\frac{Pl^3}{192EI}$
 Δ_x (when $x < \frac{l}{2}$) = $\frac{Px^2}{48EI} (3l - 4x)$

17. BEAM FIXED AT BOTH ENDS—CONCENTRATED LOAD AT
ANY POINT

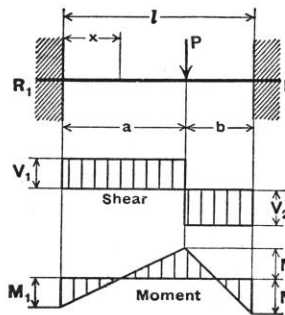

$R_1 = V_1$ (max. when $a < b$) = $\frac{Pb^2}{l^3} (3a + b)$
 $R_2 = V_2$ (max. when $a > b$) = $\frac{Pa^2}{l^3} (a + 3b)$
 M_1 (max. when $a < b$) = $\frac{Pab^2}{l^2}$
 M_2 (max. when $a > b$) = $\frac{Pa^2 b}{l^2}$
 $M a$ (at point of load) = $\frac{2Pa^2 b^2}{l^3}$
 M_x (when $x < a$) = $R_1 x - \frac{Pab^2}{l^2}$
 Δ max. (when $a > b$ at $x = \frac{2al}{3a + b}$) = $\frac{2Pa^3 b^2}{3EI (3a + b)^2}$
 Δa (at point of load) = $\frac{Pa^3 b^3}{3EI l^3}$
 Δ_x (when $x < a$) = $\frac{Pb^2 x^2}{6EI l^3} (3al - 3ax - bx)$

18. CANTILEVER BEAM—LOAD INCREASING UNIFORMLY TO FIXED END

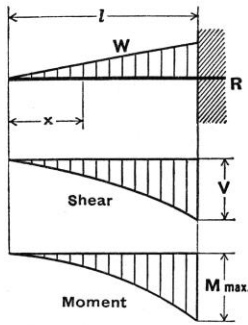

Total Equiv. Uniform Load = $\frac{8}{3} W$
 $R = V$ = W
 V_x = $W \frac{x^2}{l^2}$
 $M_{\text{max. (at fixed end)}}$ = $\frac{Wl}{3}$
 M_x = $\frac{Wx^3}{3l^2}$
 $\Delta_{\text{max. (at free end)}}$ = $\frac{Wl^3}{15EI}$
 Δ_x = $\frac{W}{60EI l^2} (x^5 - 5l^4x + 4l^5)$

$W = \frac{wl}{2}$

19. CANTILEVER BEAM—UNIFORMLY DISTRIBUTED LOAD

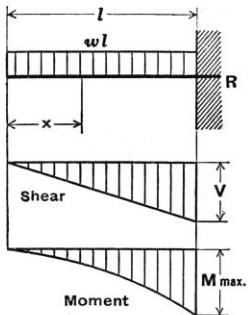

Total Equiv. Uniform Load = $4wl$
 $R = V$ = wl
 V_x = wx
 $M_{\text{max. (at fixed end)}}$ = $\frac{wl^2}{2}$
 M_x = $\frac{wx^2}{2}$
 $\Delta_{\text{max. (at free end)}}$ = $\frac{wl^4}{8EI}$
 Δ_x = $\frac{w}{24EI} (x^4 - 4l^3x + 3l^4)$

20. BEAM FIXED AT ONE END, FREE TO DEFLECT VERTICALLY BUT NOT ROTATE AT OTHER—UNIFORMLY DISTRIBUTED LOAD

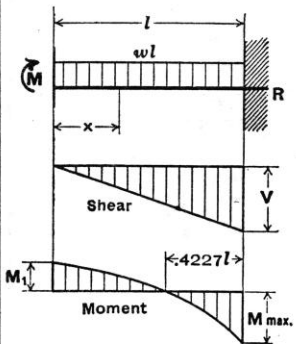

Total Equiv. Uniform Load = $\frac{8}{3} wl$
 $R = V$ = wl
 V_x = wx
 $M_{\text{max. (at fixed end)}}$ = $\frac{wl^2}{3}$
 M_1 (at deflected end) = $\frac{wl^2}{6}$
 M_x = $\frac{w}{6} (l^2 - 3x^2)$
 $\Delta_{\text{max. (at deflected end)}}$ = $\frac{wl^4}{24EI}$
 Δ_x = $\frac{w(l^2 - x^2)^2}{24EI}$

21. CANTILEVER BEAM—CONCENTRATED LOAD AT ANY POINT

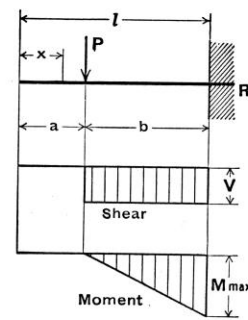

Total Equiv. Uniform Load = $\frac{8Pb}{l}$
 $R = V$ = P
 $M_{\text{max. (at fixed end)}}$ = Pb
 M_x (when $x > a$) = $P(x - a)$
 $\Delta_{\text{max. (at free end)}}$ = $\frac{Pb^2}{6EI} (3l - b)$
 Δ_a (at point of load) = $\frac{Pb^3}{3EI}$
 Δ_x (when $x < a$) = $\frac{Pb^2}{6EI} (3l - 3x - b)$
 Δ_x (when $x > a$) = $\frac{P(l - x)^2}{6EI} (3b - l + x)$

22. CANTILEVER BEAM—CONCENTRATED LOAD AT FREE END

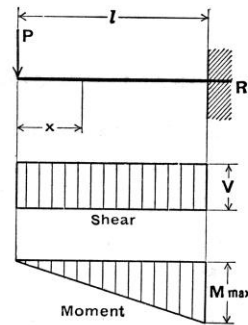

Total Equiv. Uniform Load = $8P$
 $R = V$ = P
 $M_{\text{max. (at fixed end)}}$ = Pl
 M_x = Px
 $\Delta_{\text{max. (at free end)}}$ = $\frac{Pl^3}{3EI}$
 Δ_x = $\frac{P}{6EI} (2l^3 - 3l^2x + x^3)$

23. BEAM FIXED AT ONE END, FREE TO DEFLECT VERTICALLY BUT NOT ROTATE AT OTHER—CONCENTRATED LOAD AT DEFLECTED END

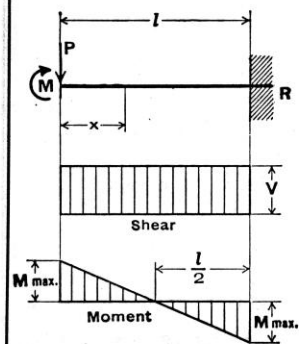

Total Equiv. Uniform Load = $4P$
 $R = V$ = P
 $M_{\text{max. (at both ends)}}$ = $\frac{Pl}{2}$
 M_x = $P(\frac{l}{2} - x)$
 $\Delta_{\text{max. (at deflected end)}}$ = $\frac{Pl^3}{12EI}$
 Δ_x = $\frac{P(l - x)^2}{12EI} (l + 2x)$

24. BEAM OVERHANGING ONE SUPPORT—UNIFORMLY DISTRIBUTED LOAD

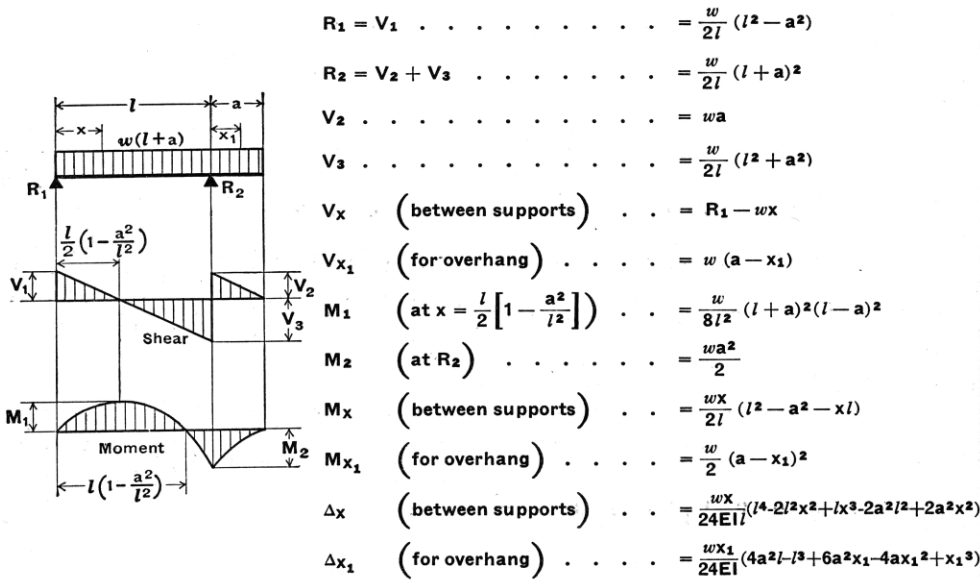

25. BEAM OVERHANGING ONE SUPPORT—UNIFORMLY DISTRIBUTED LOAD ON OVERHANG

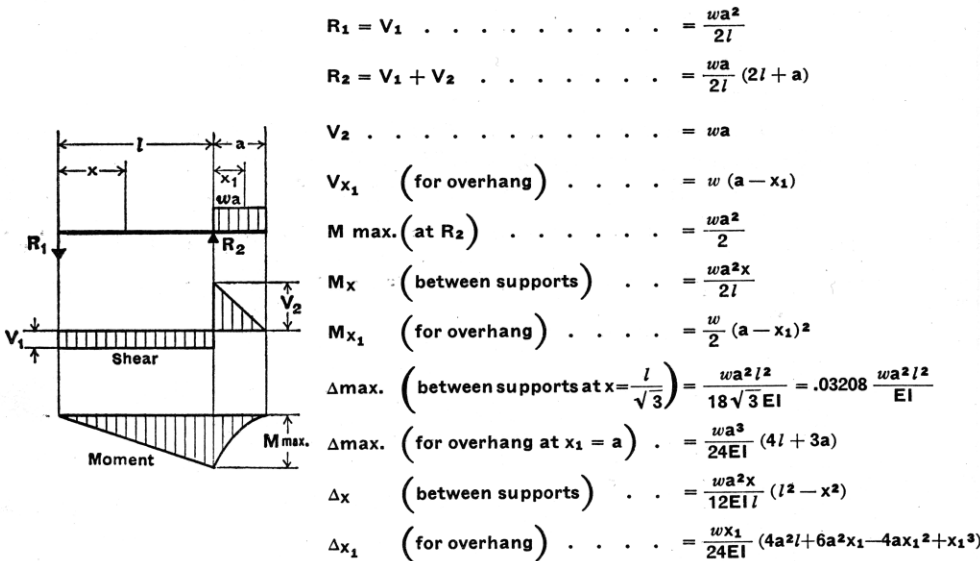

26. BEAM OVERHANGING ONE SUPPORT—CONCENTRATED LOAD AT END OF OVERHANG

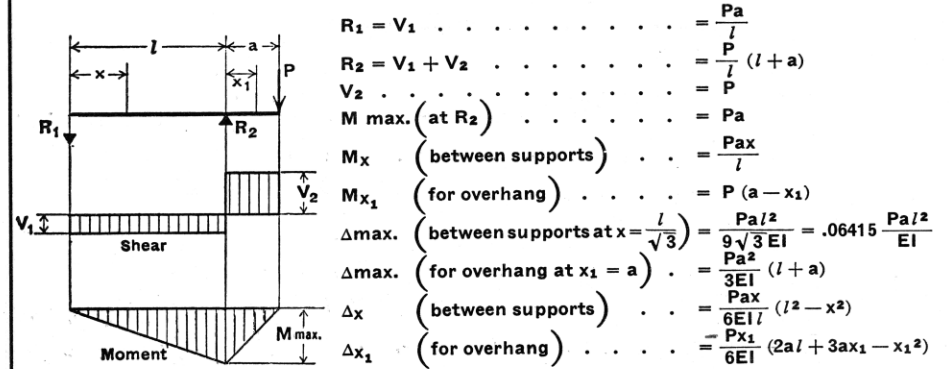

27. BEAM OVERHANGING ONE SUPPORT—UNIFORMLY DISTRIBUTED LOAD BETWEEN SUPPORTS

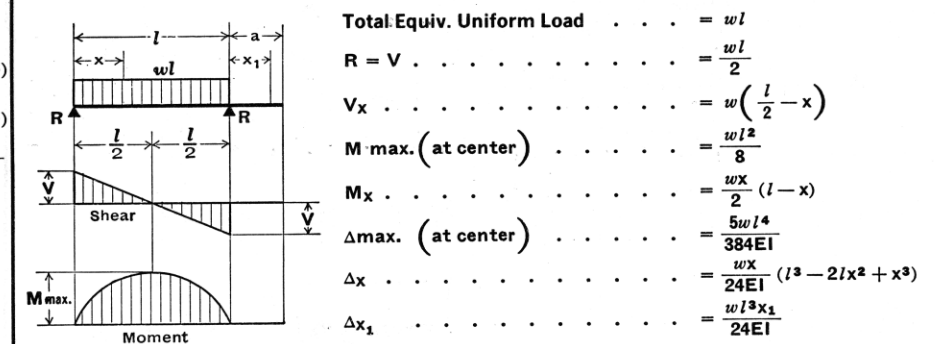

28. BEAM OVERHANGING ONE SUPPORT—CONCENTRATED LOAD AT ANY POINT BETWEEN SUPPORTS

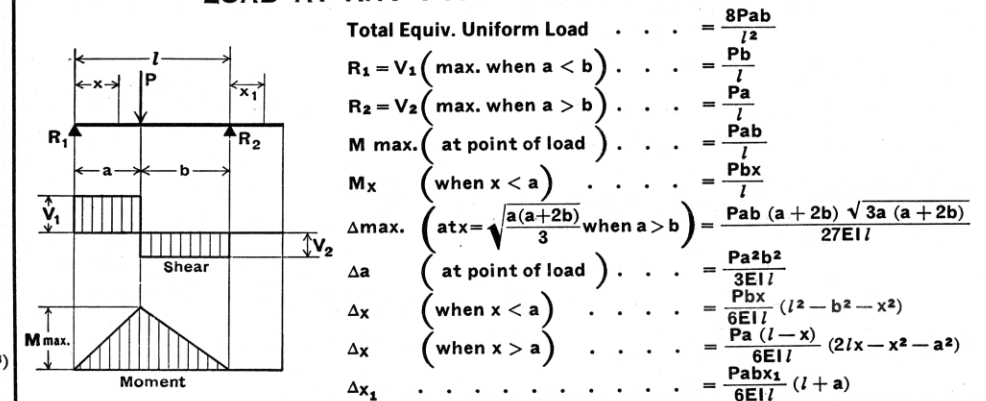

29. CONTINUOUS BEAM—TWO EQUAL SPANS—UNIFORM LOAD ON ONE SPAN

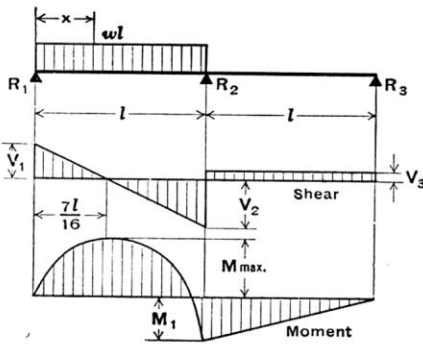

Total Equiv. Uniform Load = $\frac{49}{64} wl$
 $R_1 = V_1 = \frac{7}{16} wl$
 $R_2 = V_2 + V_3 = \frac{5}{8} wl$
 $R_3 = V_3 = \frac{1}{16} wl$
 $V_2 = \frac{9}{16} wl$
 $M_{max.} \text{ (at } x = \frac{7}{16} l \text{)} = \frac{49}{512} wl^2$
 $M_1 \text{ (at support } R_2 \text{)} = \frac{1}{16} wl^2$
 $M_x \text{ (when } x < l \text{)} = \frac{wx}{16} (7l - 8x)$
 $\Delta_{Max.} \text{ (0.472 } l \text{ from } R_1 \text{)} = 0.0092 wl^4/EI$

30. CONTINUOUS BEAM—TWO EQUAL SPANS—CONCENTRATED LOAD AT CENTER OF ONE SPAN

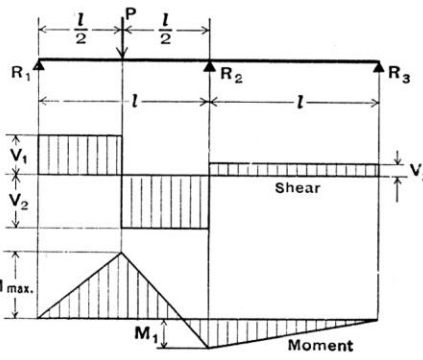

Total Equiv. Uniform Load = $\frac{13}{8} P$
 $R_1 = V_1 = \frac{13}{32} P$
 $R_2 = V_2 + V_3 = \frac{11}{16} P$
 $R_3 = V_3 = \frac{3}{32} P$
 $V_2 = \frac{19}{32} P$
 $M_{max.} \text{ (at point of load)} = \frac{13}{64} Pl$
 $M_1 \text{ (at support } R_2 \text{)} = \frac{3}{32} Pl$
 $\Delta_{Max.} \text{ (0.480 } l \text{ from } R_1 \text{)} = 0.015 P l^3/EI$

31. CONTINUOUS BEAM—TWO EQUAL SPANS—CONCENTRATED LOAD AT ANY POINT

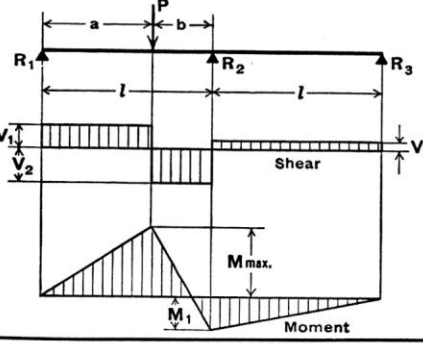

$R_1 = V_1 = \frac{Pb}{4l^3} (4l^2 - a(l+a))$
 $R_2 = V_2 + V_3 = \frac{Pa}{2l^3} (2l^2 + b(l+a))$
 $R_3 = V_3 = \frac{Pab}{4l^3} (l+a)$
 $V_2 = \frac{Pa}{4l^3} (4l^2 + b(l+a))$
 $M_{max.} \text{ (at point of load)} = \frac{Pab}{4l^3} (4l^2 - a(l+a))$
 $M_1 \text{ (at support } R_2 \text{)} = \frac{Pab}{4l^2} (l+a)$

32. BEAM—UNIFORMLY DISTRIBUTED LOAD AND VARIABLE END MOMENTS

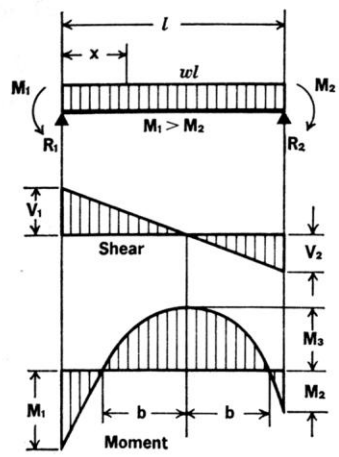

$R_1 = V_1 = \frac{wl}{2} + \frac{M_1 - M_2}{l}$
 $R_2 = V_2 = \frac{wl}{2} - \frac{M_1 - M_2}{l}$
 $V_x = w \left(\frac{l}{2} - x \right) + \frac{M_1 - M_2}{l}$
 $M_3 \text{ (at } x = \frac{l}{2} + \frac{M_1 - M_2}{wl} \text{)}$
 $= \frac{wl^2}{8} - \frac{M_1 + M_2}{2} + \frac{(M_1 - M_2)^2}{2wl^2}$
 $M_x = \frac{wx}{2} (l - x) + \left(\frac{M_1 - M_2}{l} \right) x - M_1$
 $b \text{ (To locate inflection points)} = \sqrt{\frac{l^2}{4} - \left(\frac{M_1 + M_2}{w} \right) + \left(\frac{M_1 - M_2}{wl} \right)^2}$
 $\Delta_x = \frac{wx}{24EI} \left[x^3 - \left(2l + \frac{4M_1}{wl} - \frac{4M_2}{wl} \right) x^2 + \frac{12M_1}{w} x + l^3 - \frac{8M_1l}{w} - \frac{4M_2l}{w} \right]$

33. BEAM—CONCENTRATED LOAD AT CENTER AND VARIABLE END MOMENTS

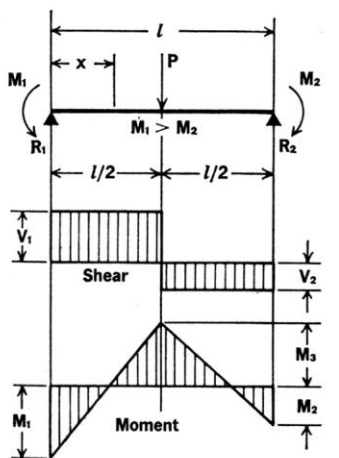

$R_1 = V_1 = \frac{P}{2} + \frac{M_1 - M_2}{l}$
 $R_2 = V_2 = \frac{P}{2} - \frac{M_1 - M_2}{l}$
 $M_3 \text{ (At center)} = \frac{Pl}{4} - \frac{M_1 + M_2}{2}$
 $M_x \text{ (When } x < \frac{l}{2} \text{)} = \left(\frac{P}{2} + \frac{M_1 - M_2}{l} \right) x - M_1$
 $M_x \text{ (When } x > \frac{l}{2} \text{)} = \frac{P}{2} (l - x) + \frac{(M_1 - M_2)x}{l} - M_1$
 $\Delta_x \text{ (When } x < \frac{l}{2} \text{)} = \frac{Px}{48EI} \left(3l^2 - 4x^2 - \frac{8(l-x)}{Pl} [M_1(2l-x) + M_2(l+x)] \right)$

34. CONTINUOUS BEAM—THREE EQUAL SPANS—ONE END SPAN UNLOADED

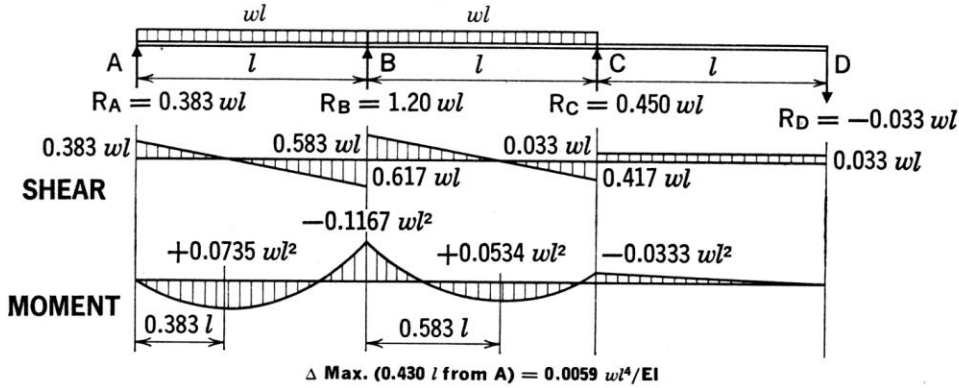

35. CONTINUOUS BEAM—THREE EQUAL SPANS—END SPANS LOADED

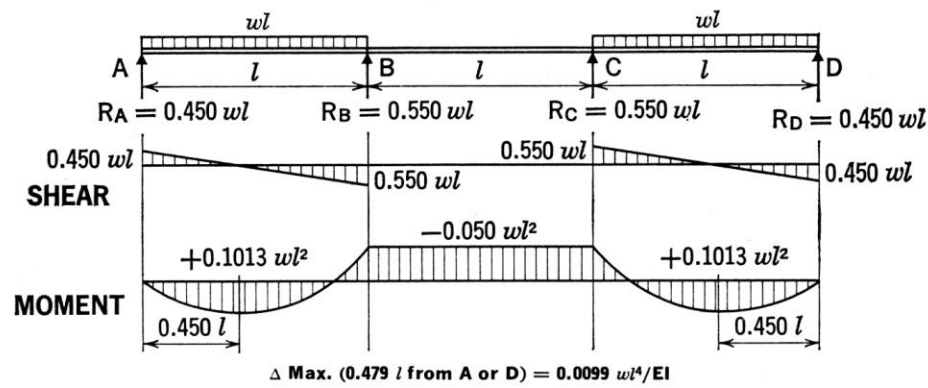

36. CONTINUOUS BEAM—THREE EQUAL SPANS—ALL SPANS LOADED

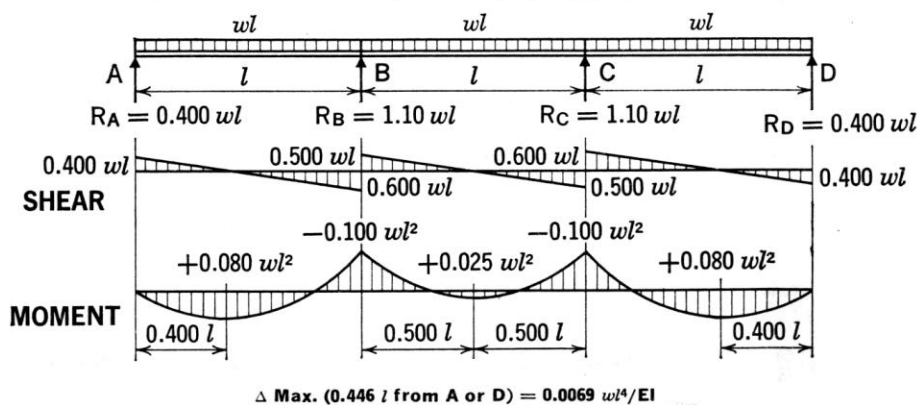

37. CONTINUOUS BEAM—FOUR EQUAL SPANS—THIRD SPAN UNLOADED

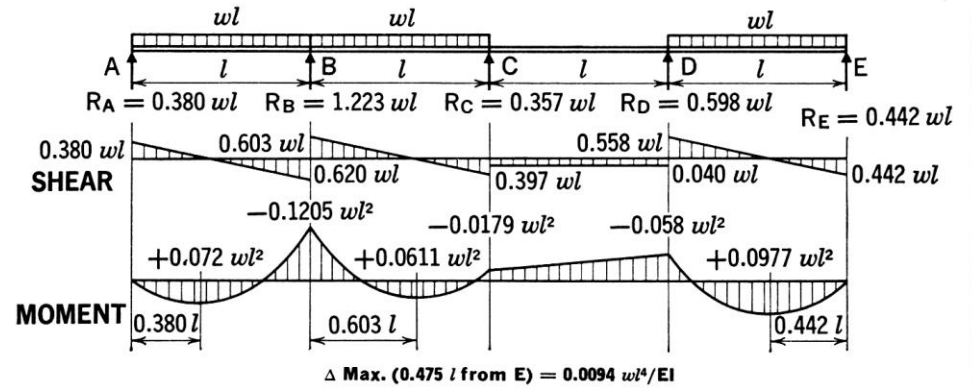

38. CONTINUOUS BEAM—FOUR EQUAL SPANS—LOAD FIRST AND THIRD SPANS

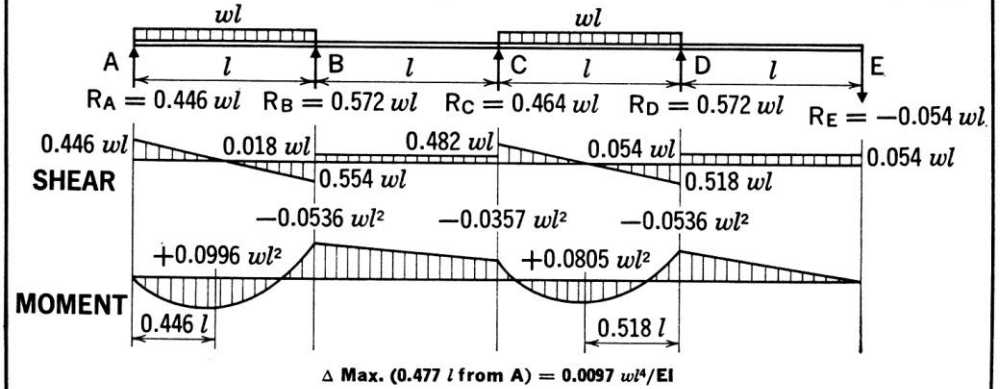

39. CONTINUOUS BEAM—FOUR EQUAL SPANS—ALL SPANS LOADED

