

*ELEMENTS OF ARCHITECTURAL STRUCTURES:  
FORM, BEHAVIOR, AND DESIGN*

ARCH 614

DR. ANNE NICHOLS

SPRING 2014

lecture  
*twenty eight*

*shells &  
structural systems*



# Office Hours

---

**Professor Anne Nichols (845-6540)**



*link to posted schedule*

8  
9  
10  
11  
12  
1  
2  
3  
4 pm

# Arch & Shell Systems

---

- *curved, thin surface or 2D structures*
- *see very little bending stresses*
- *design for*
  - *axial stresses*
  - *shear stresses*
- *efficient because of uniformly distributed loads*



*Millennium Bridge in Newcastle, UK*

# Arches

- *behavior*
  - *stabilization*
  - *resist thrust*
- *compression*  
*only*

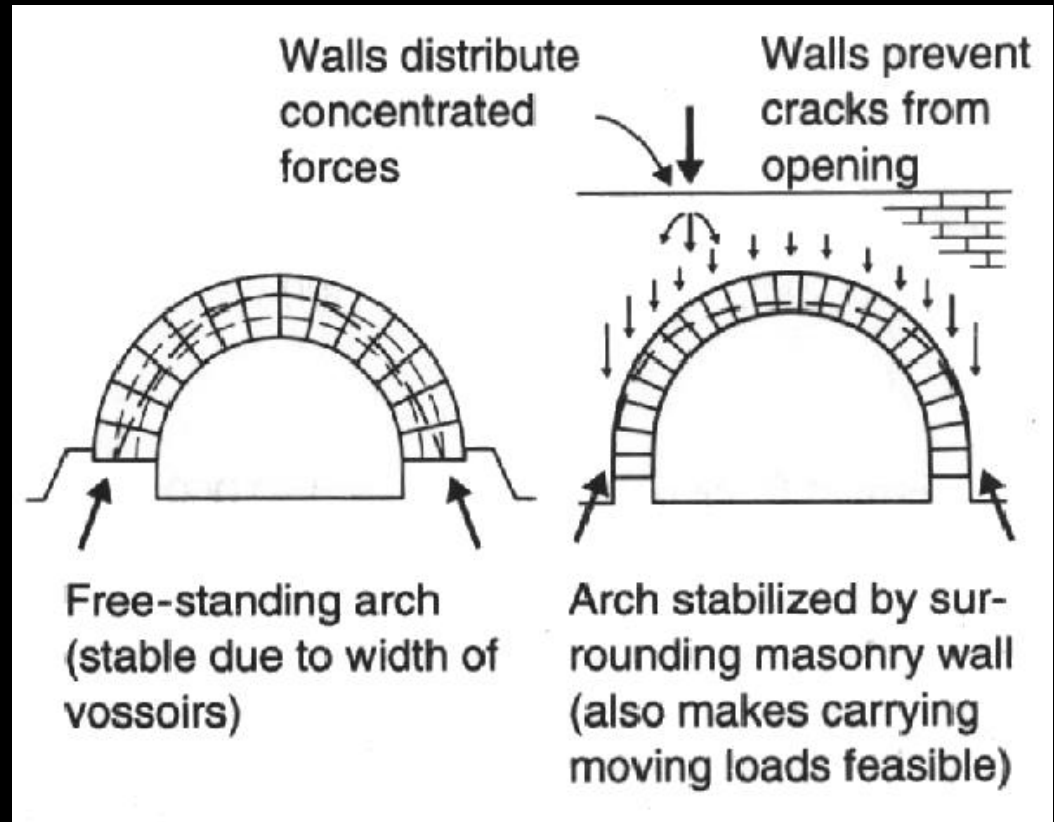

# Shell Types

- *shape classifications*
  - *developable:*
    - *revolution (vault)*
  - *synclastic*
    - *doubly curved*
    - *same direction*
  - *anticlastic:*
    - *doubly curved*
    - *opposite curvature*
  - *free form*

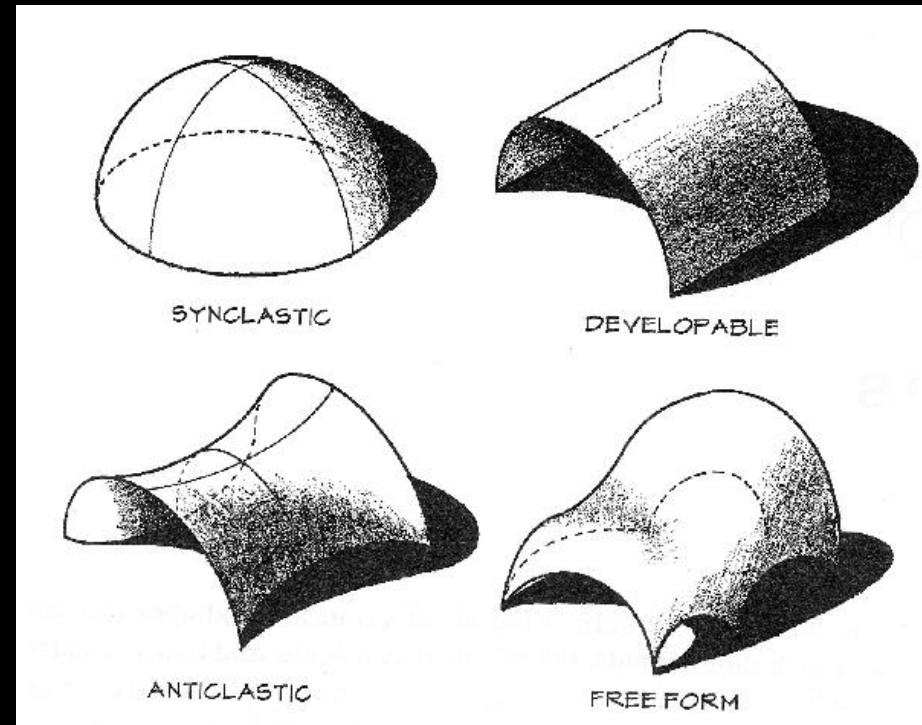



# Vaults

- “wide” arch

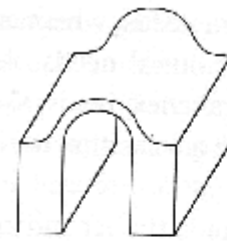

(a) Single Vault

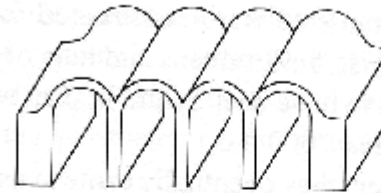

(b) Series of Vaults

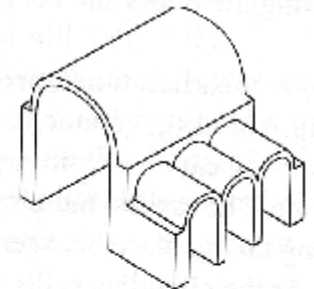

(c) Lateral Vaults (Normal)

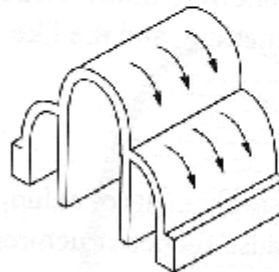

(d) Lateral Vaults (Parallel)

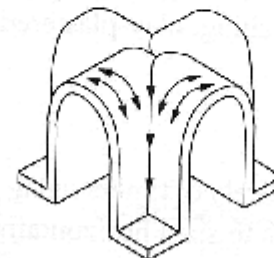

(e) Cross or Groin Vault

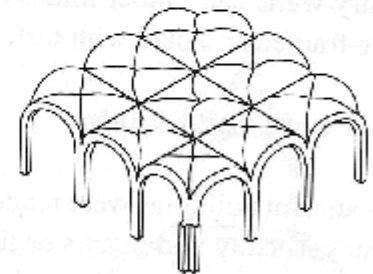

(f) Multiple Cross Groin Vault

<http://nisee.berkeley.edu/godden>

# Vaulted Shells

- *can resist tension*
- *shape adds “depth”*

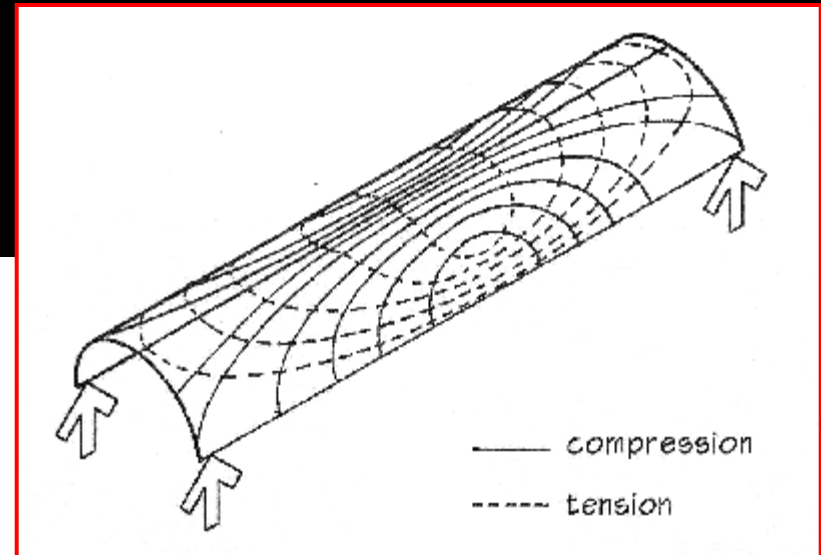
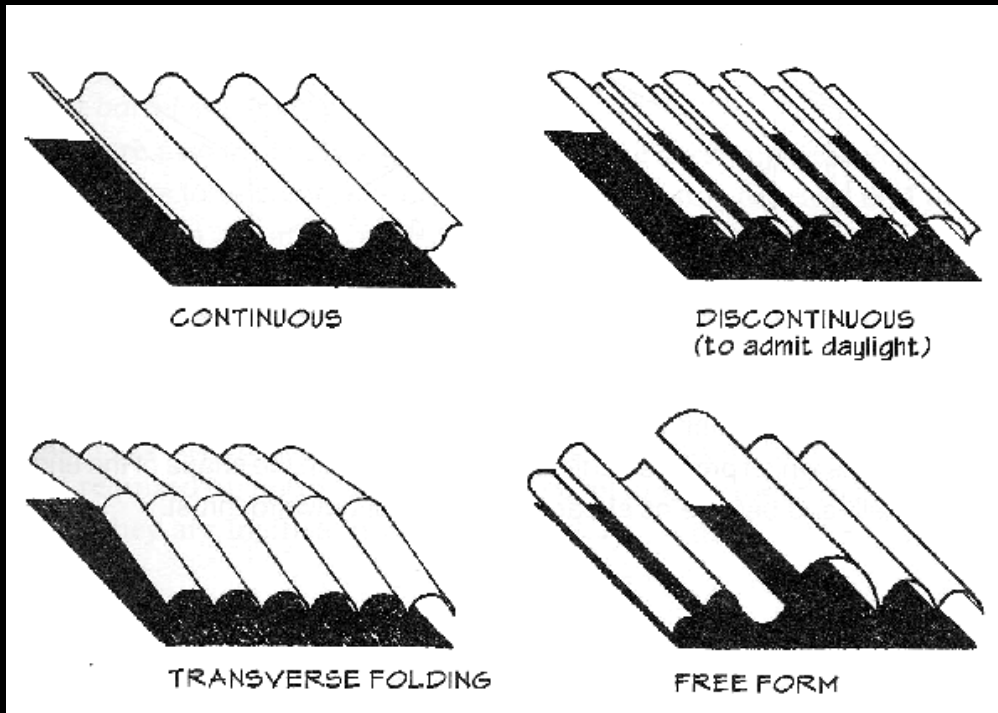

# *Kimball Museum, Kahn 1972*

---





# Kimball Museum, Kahn 1972

- *outer shell edges*

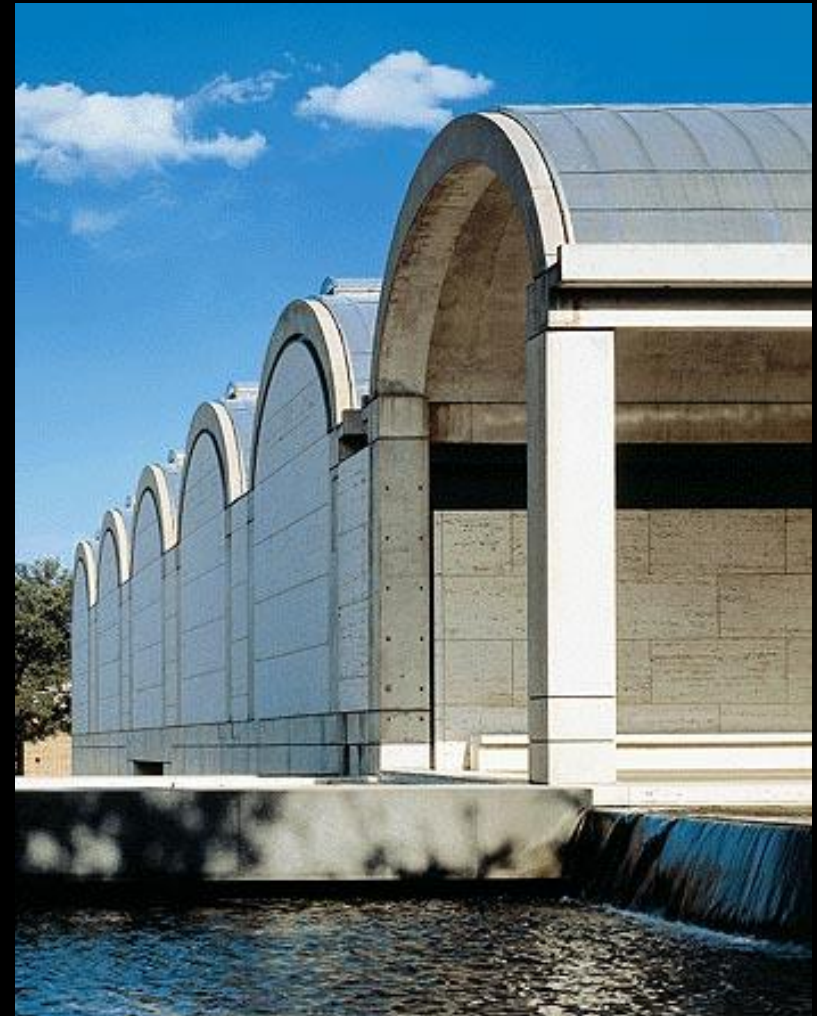
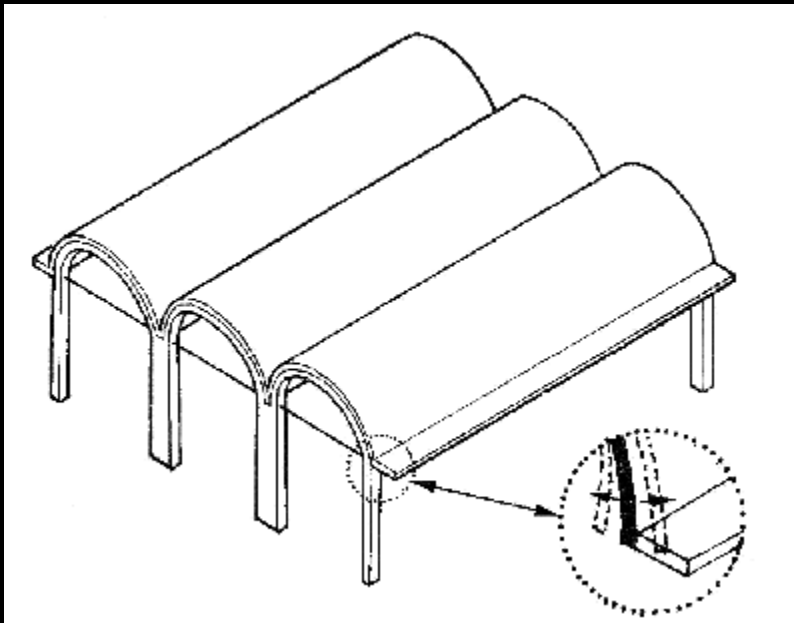

# Kimball Museum, Kahn 1972

- skylights at peak

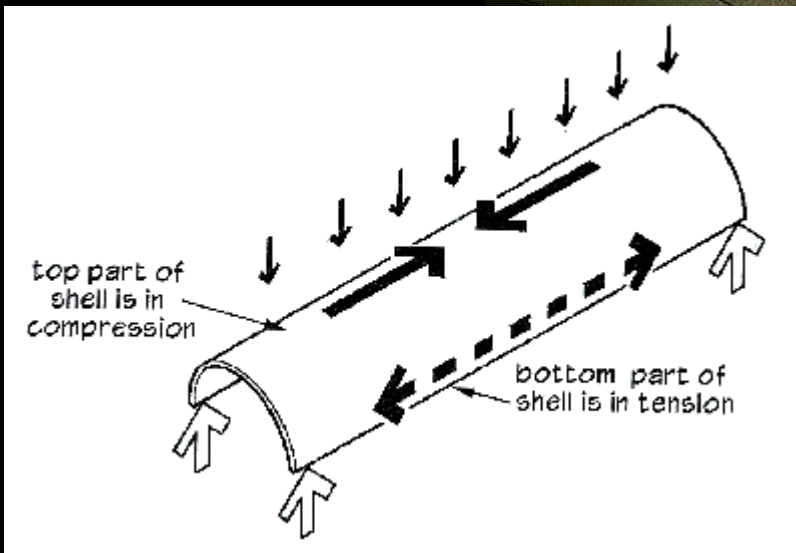
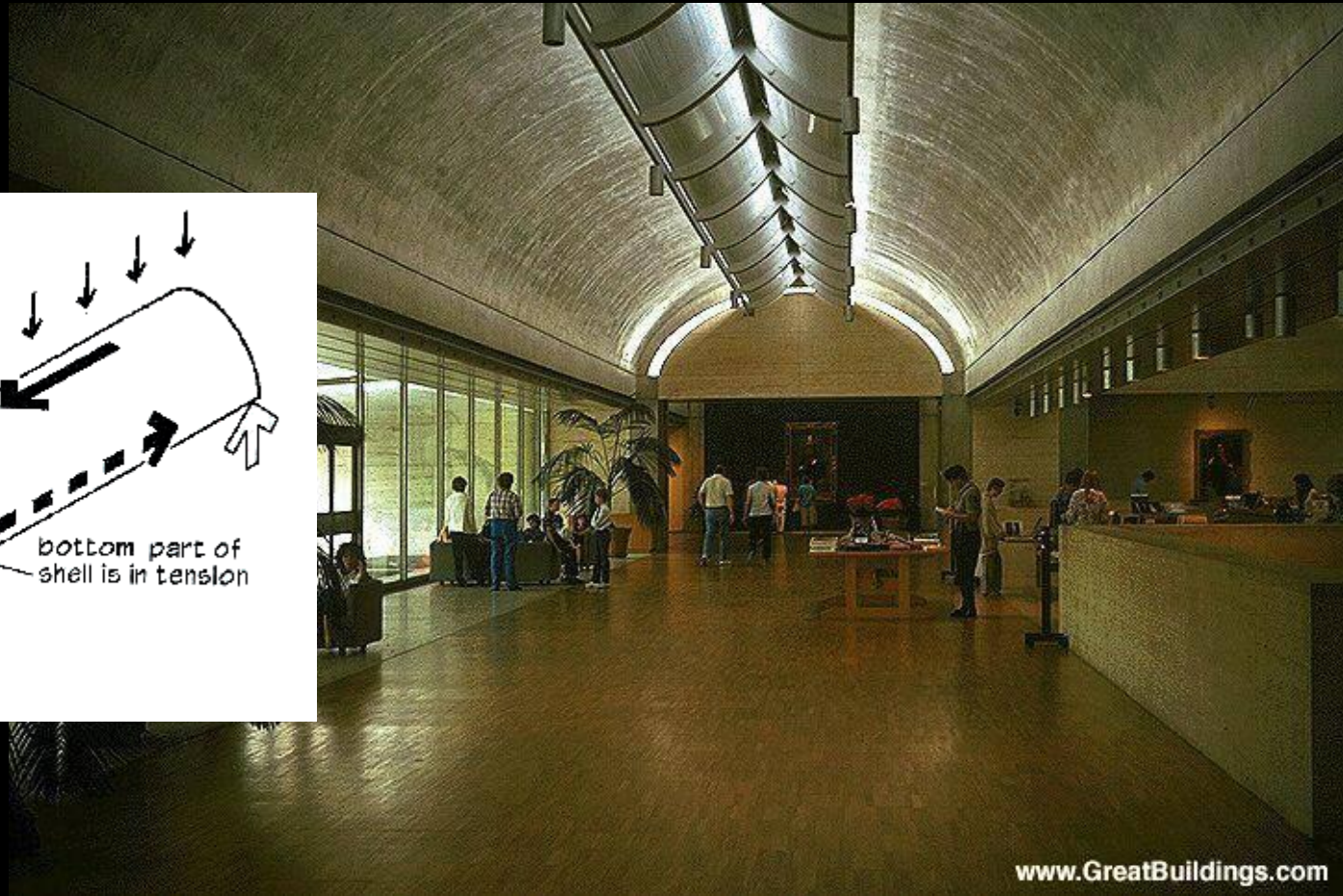

# Domes

- *arch of revolution*
- *compression*
- *some tension*

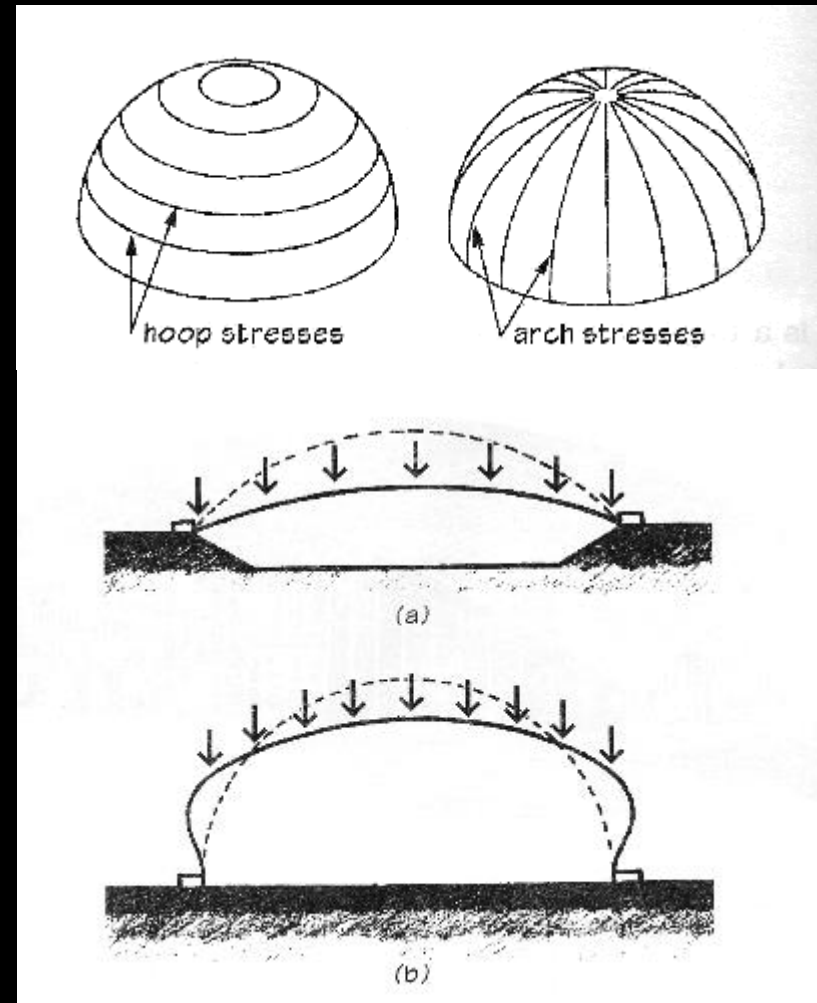
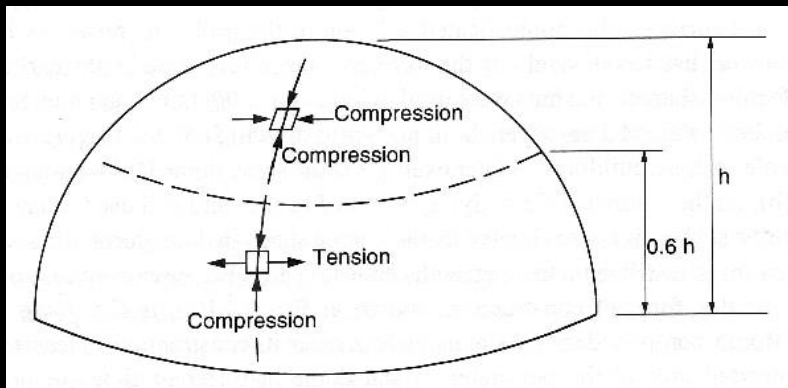



# Domes

- stresses and displacements

© Harvard GSD

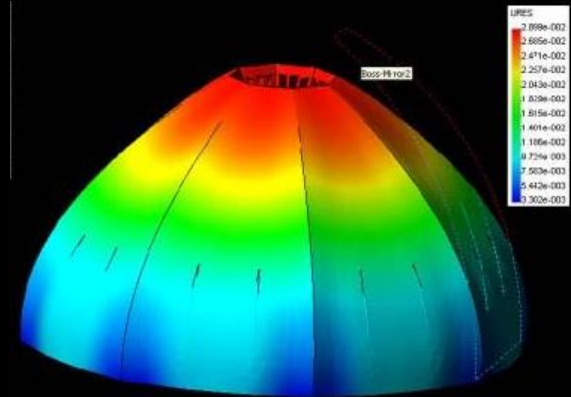
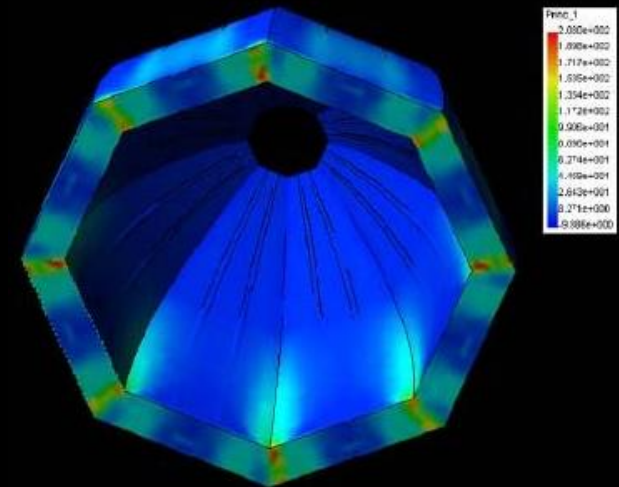



# *Annunciation Greek Orthodox Church*

---

- *Wright, 1956*



# Annunciation Greek Orthodox Church

- *Wright, 1956*

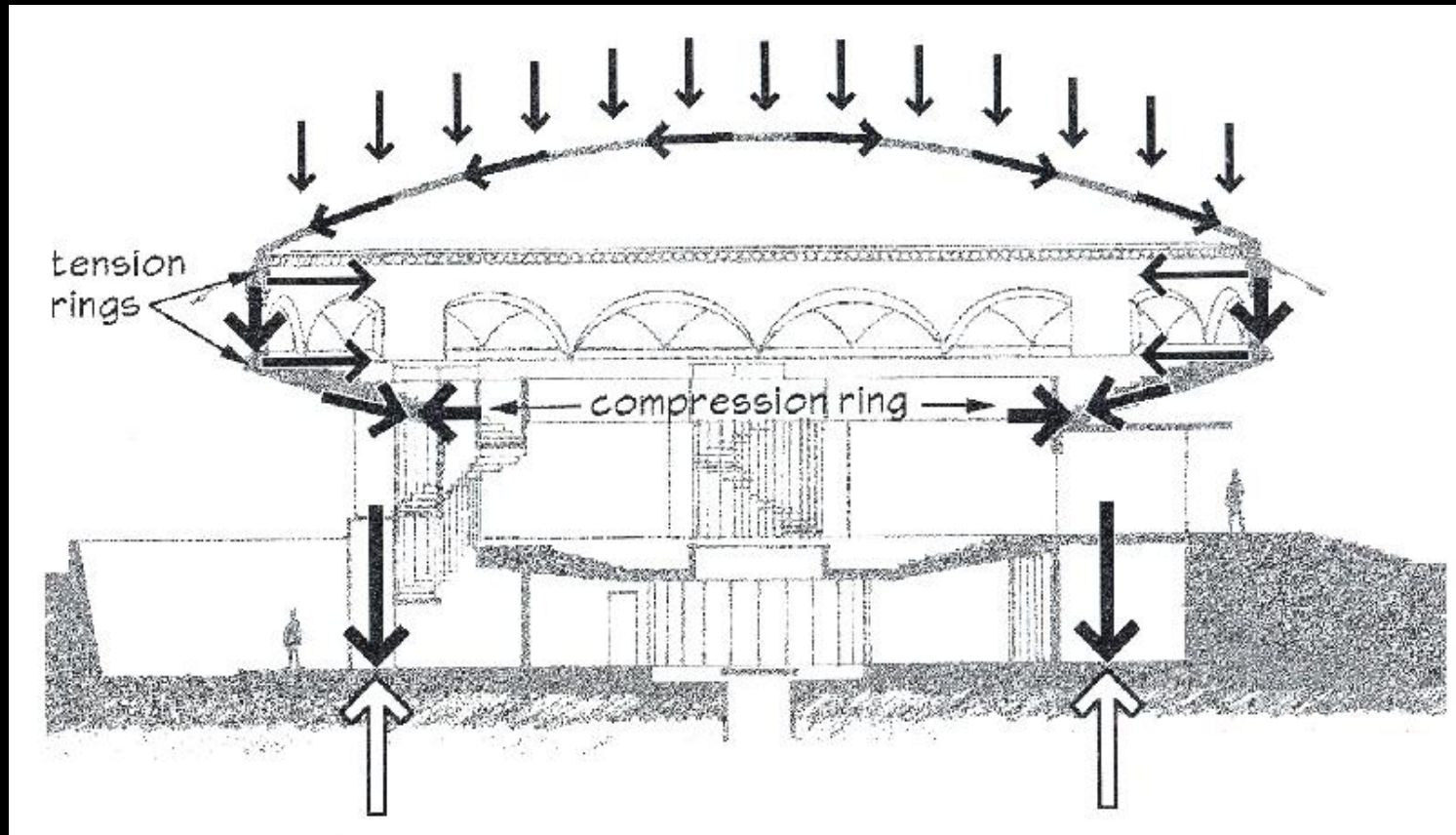

# *Anticlastic Shells*

---

- *saddle or “ruled” shapes*
- *surface generated with straight lines*



- *tension follows “cable drape”*
- *compression follows “arch”*

# Zarzuela Hippodrome, Torroja 1935

---



<http://www.bluffton.edu>



# Zarzuela Hippodrome, Torroja 1935

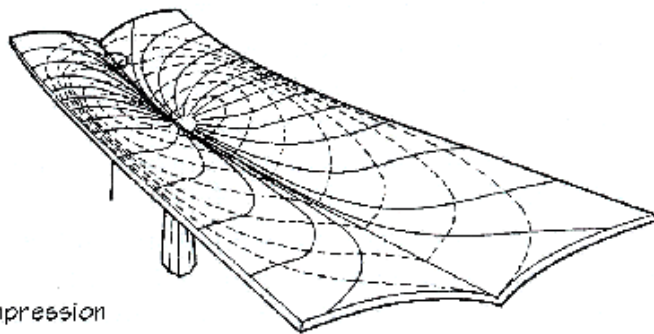
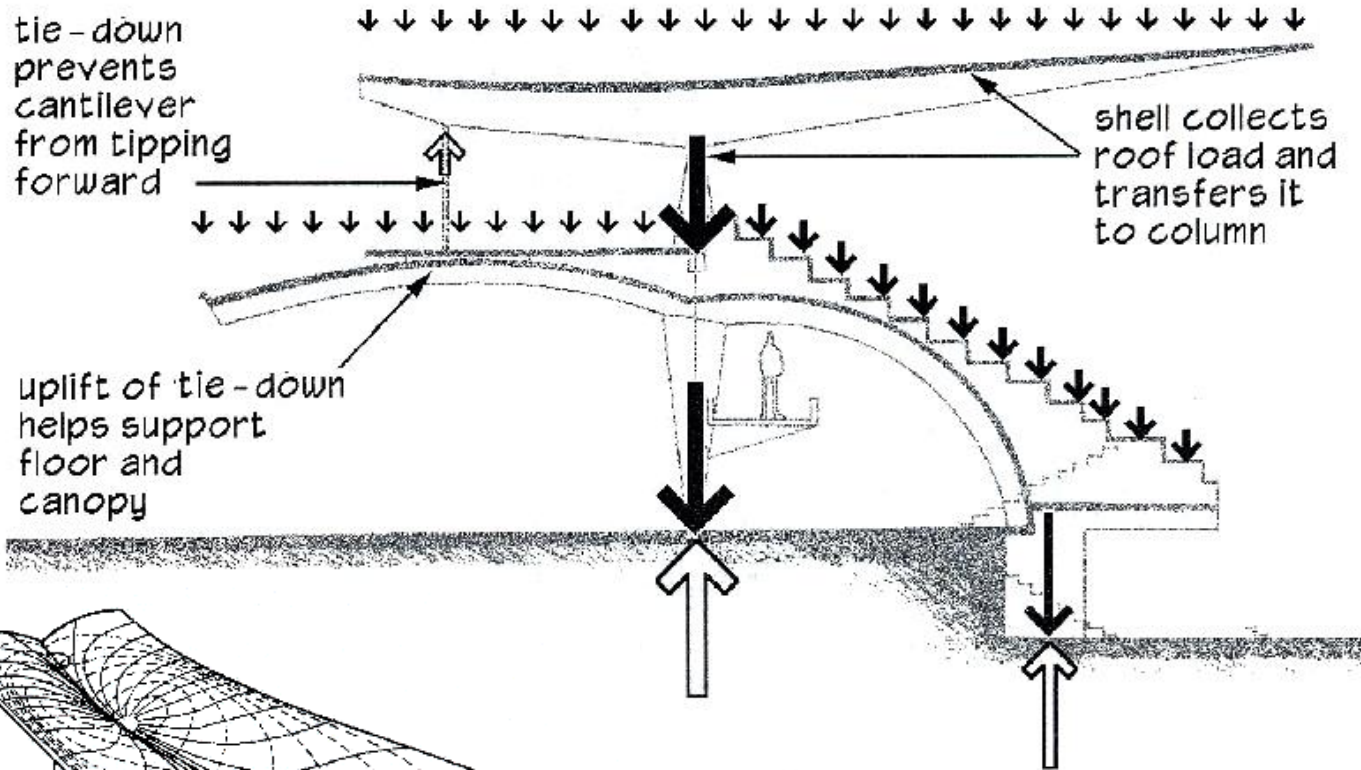

——— compression  
- - - - - tension

# Folded Plates

- *increased stiffness with folding*

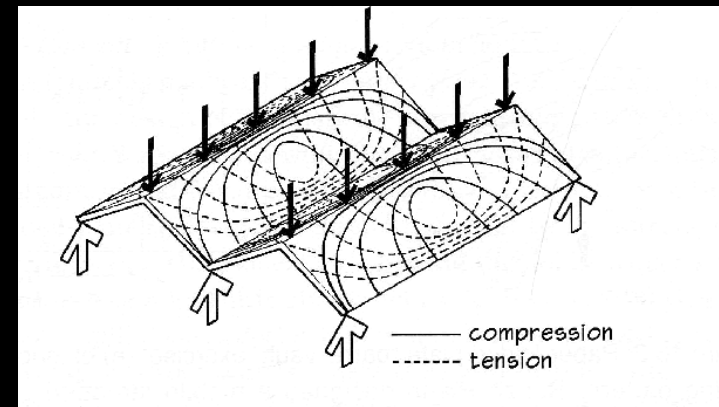
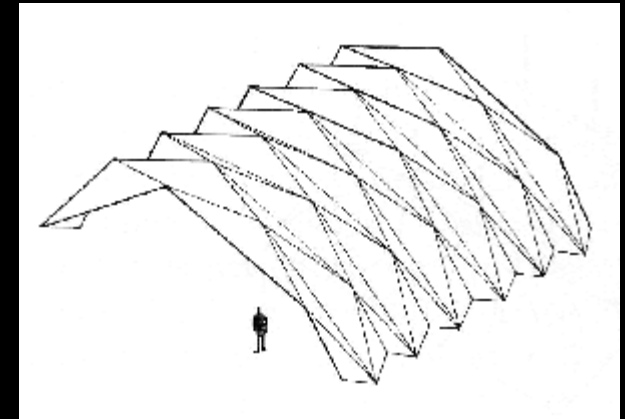
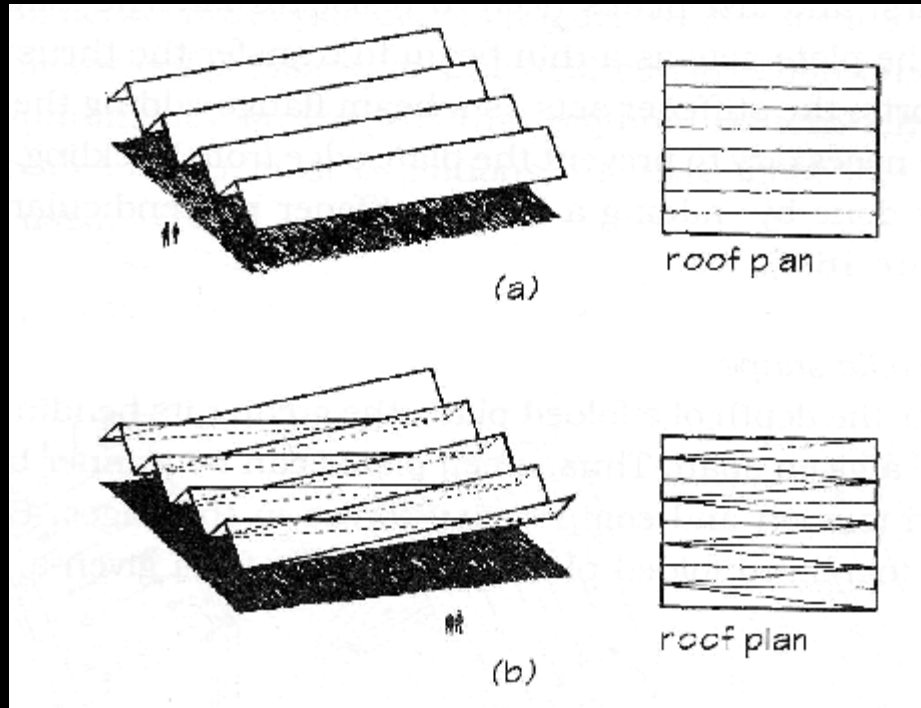

# State Farm Center, Harrison & Abramovitz 1963



[www.library.illinois.edu](http://www.library.illinois.edu)

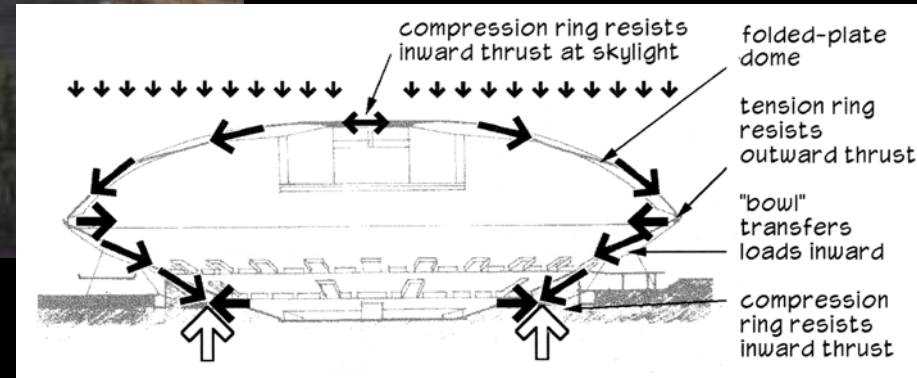

- *State Farm Center (Assembly Hall), University of Illinois*
- *Harrison & Abramovitz 1963*
- *Edge-supported dome spanning 400 feet wound with 614 miles of one-fifth inch steel wire*

# Systems

- *total of components*
- *behavior of whole*
- *classifications*
  - *one-way*
  - *two-way*
  - *tubes*
  - *braced*
  - *unbraced*

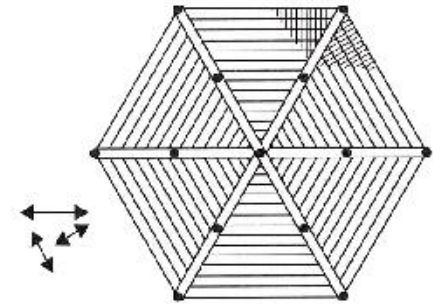

(a) One-way radial beam-and-column system for a hexagonal or circular configuration.

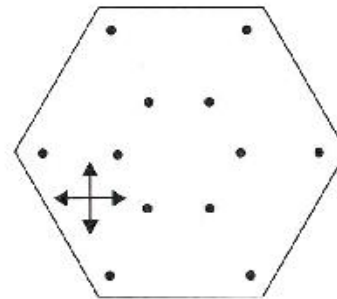

(c) Two-way flat-plate system (without beams) for a hexagonal or circular configuration.

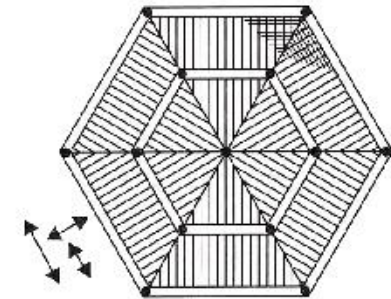

(b) One-way circumferential beam-and-column system plan for hexagonal or circular configuration.



# One-Way Systems

- *horizontal vs. vertical*

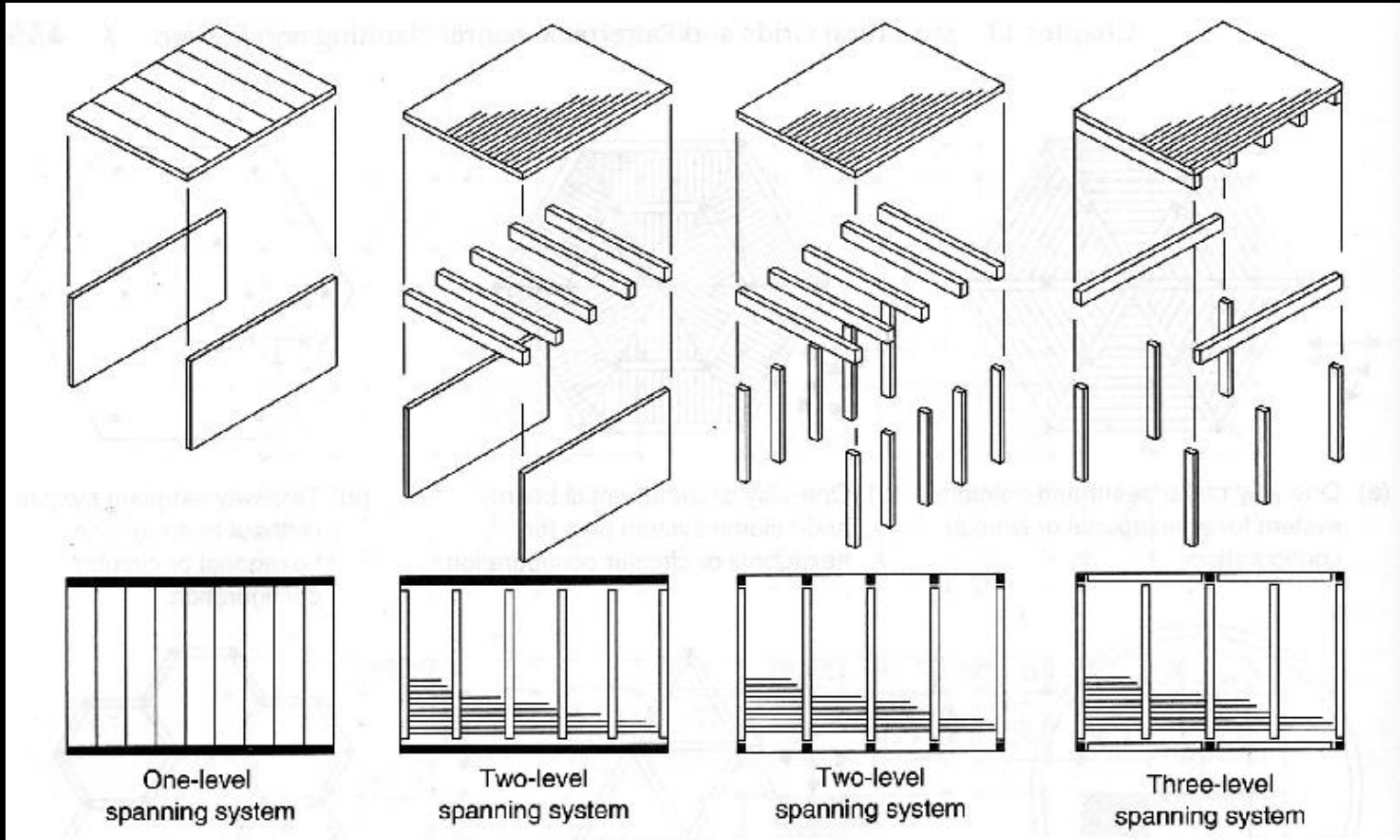

# Two-Way Systems

- *spanning system less obvious*
- *horizontal*
  - *plates*
  - *slabs*
  - *space frames*
- *vertical*
  - *columns*
  - *walls*

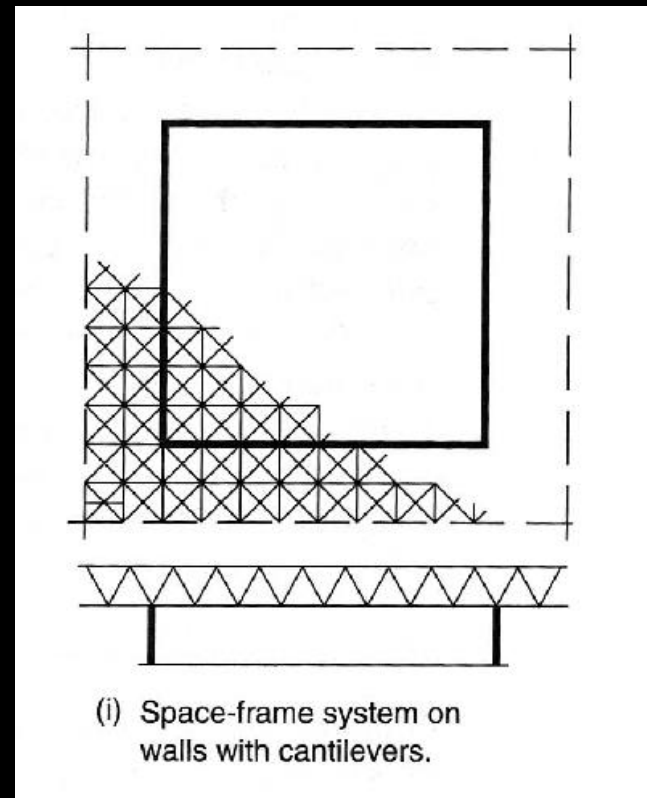

# System Selection

- *evaluation of alternatives*

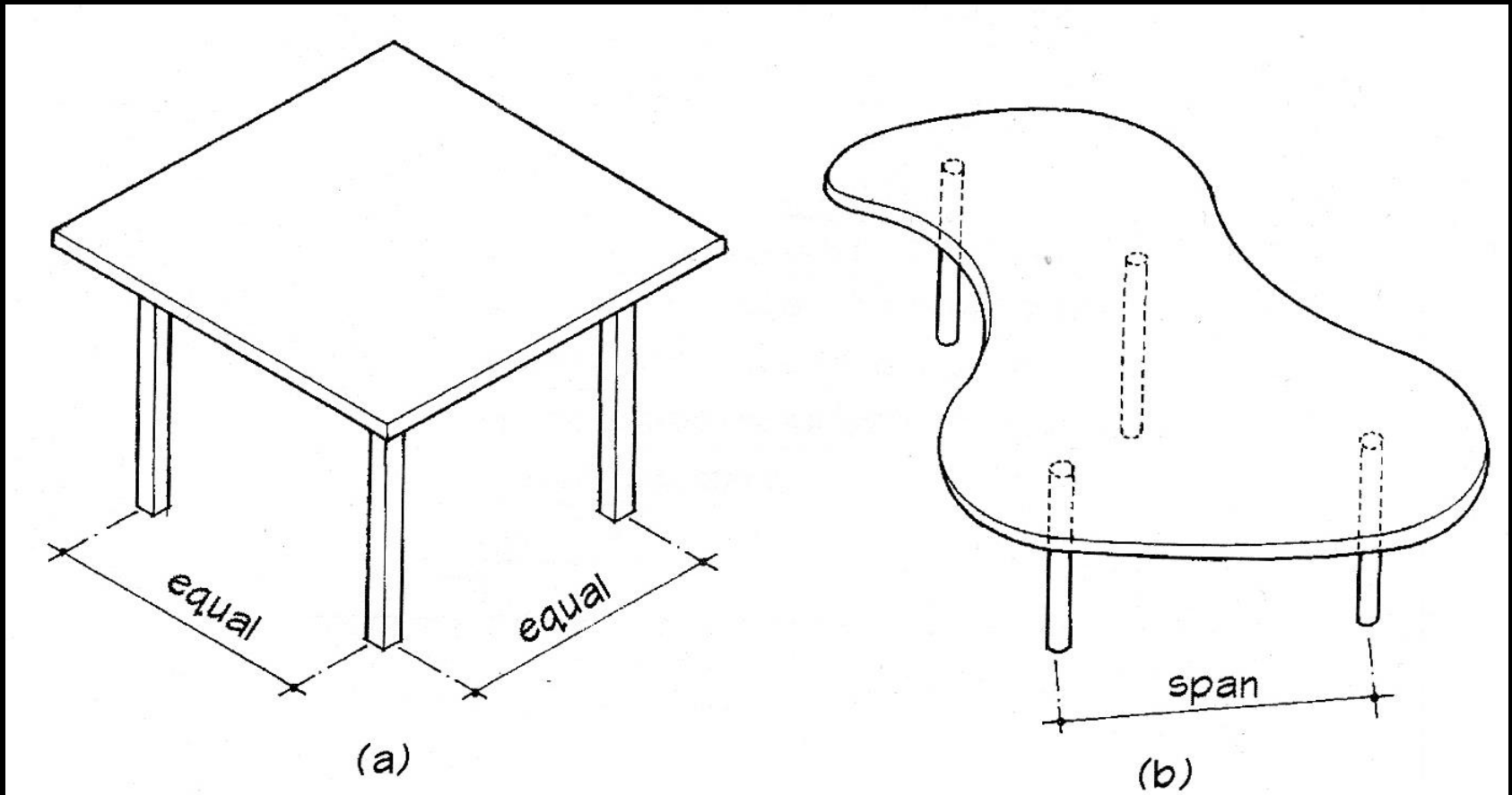

DESIGN CRITERIA	Light-frame timber	Heavy-frame timber	Masonry bearing wall	Steel frame (hinge connections)	Steel frame (rigid connections)	Steel open-web joists	Steel space frame	Steel decking	Site-cast concrete: one-way slab	Site-cast concrete: two-way plate	Site-cast concrete: two-way slab	Site-cast concrete: one-way joists	Site-cast concrete: waffle slab	Precast concrete: solid slab	Precast concrete: hollow-core slab	Precast concrete: single tee	Precast concrete: double tee	RATIONALE
Exposed, fire-resiant construction																		Inherently fire-resistive construction
Irregular building form																		Simple, site-fabricated systems
Irregular column placement																		Systems without beams in roof or floors
Minimize floor thickness																		Precast-concrete systems without ribs
Allow for future renovations																		Short-span, one-way, easily modified
Permit construction in poor weather																		Quickly erected; avoid site-cast concrete
Minimize off-site fabrication time																		Easily formed or built on site
Minimize on-site erection time																		Highly prefabricated; modular components
Minimize low-rise construction time																		Lightweight, easily formed or prefabricated
Minimize medium-rise construction time																		Precast, site-cast concrete; steel frames
Minimize high-rise construction time																		Strong; prefabricated; lightweight
Minimize shear walls or diagonal bracing																		Capable of forming rigid joints
Minimize dead load on foundations																		Lightweight, short-span systems
Minimize damage due to foundation settlement																		Systems without rigid joints
Minimize the number of separate trades on job																		Multipurpose components
Provide concealed space for mech. services																		Systems that inherently provide voids
Minimize the number of supports																		Two-way, long-span systems
Long spans																		Long-span systems



# Structural Design Criteria

- *components stay together*
- *structure acts as whole to be stable*
  - *resist sliding*
  - *resist overturning*
  - *resist twisting and distortion*
- *internal stability*
  - *interconnectedness*
- *strength & stiffness*

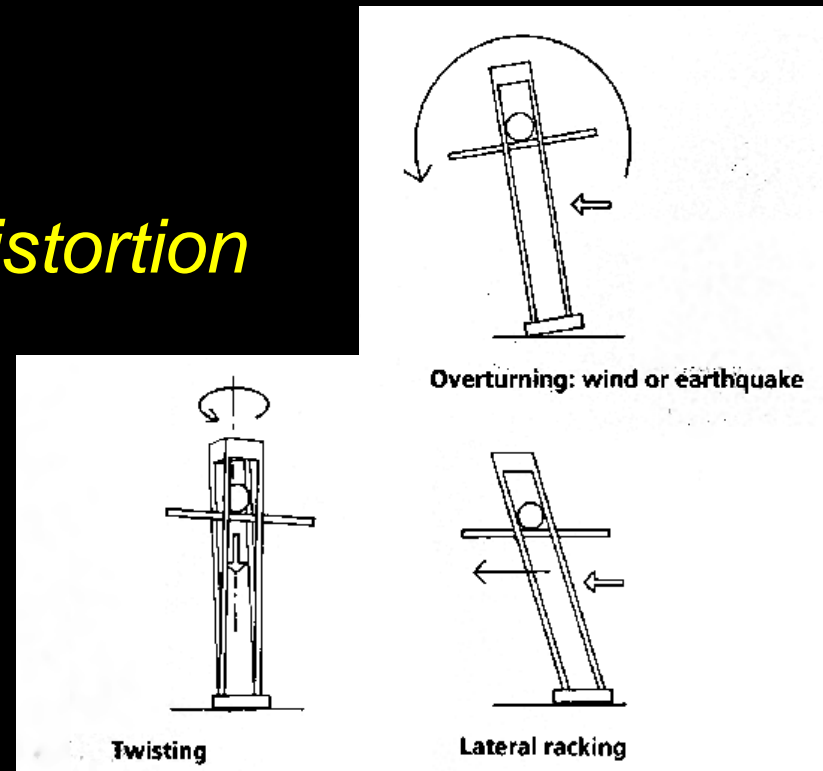

# Structural Design Sequences

---

- *first-order design*
  - *structural type and organization*
  - *design intent*
  - *contextual or programmatic*
- *second-order*
  - *structural strategies*
  - *material choice*
  - *structural systems*
- *third-order*
  - *member shaping & sizing*

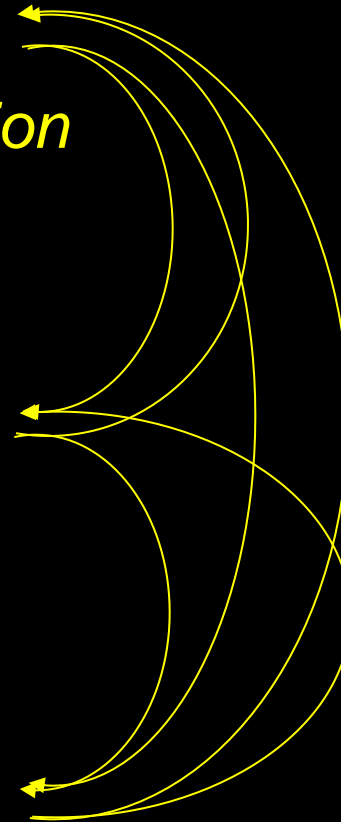

# Design Issues

- *lateral stability – all directions*

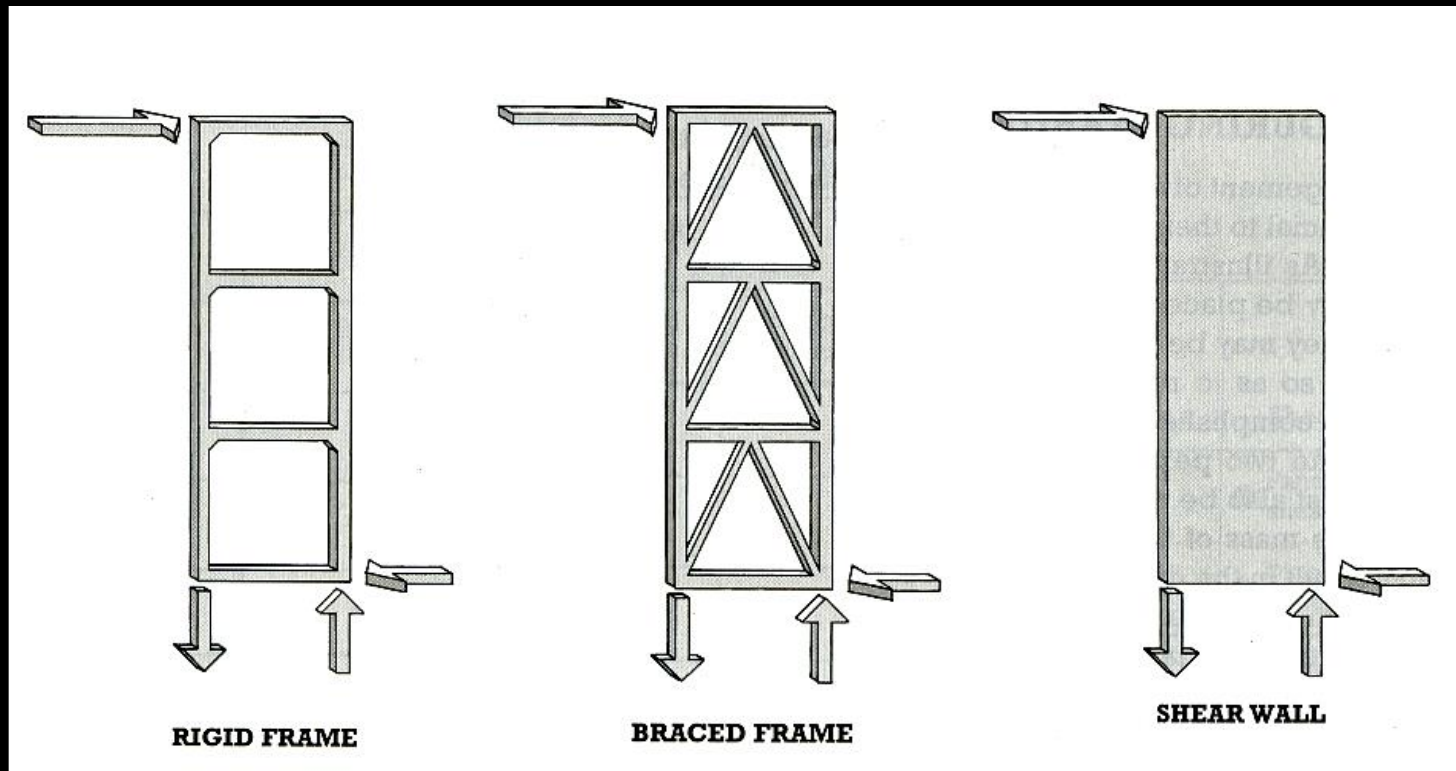

# Design Issues

- *configuration*

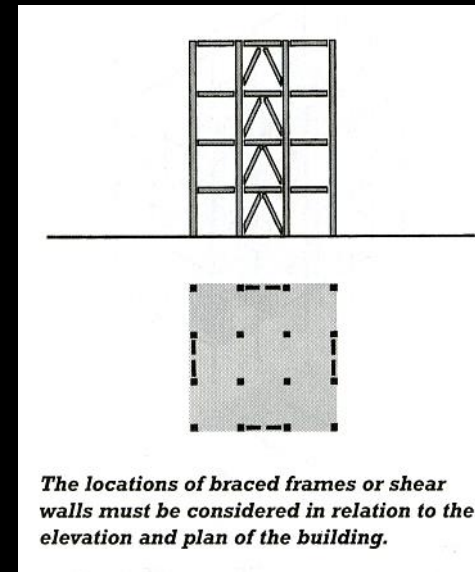
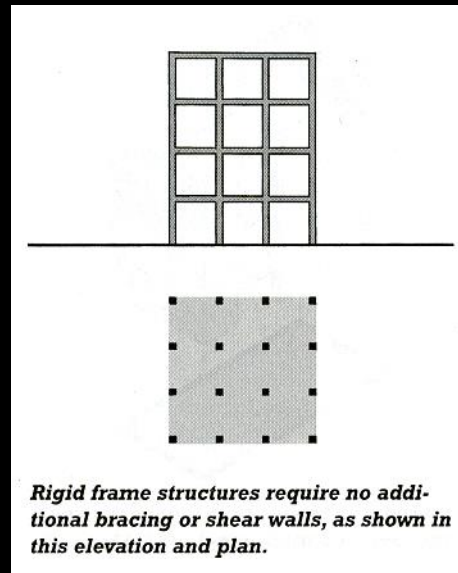
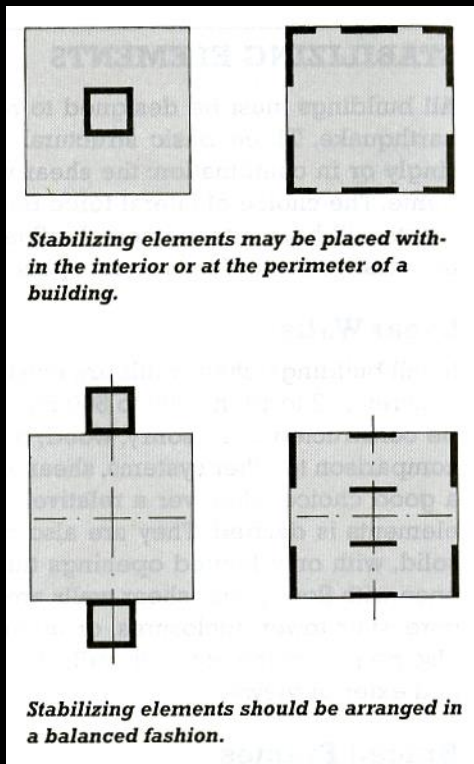



# Design Issues

- *vertical load resistance*

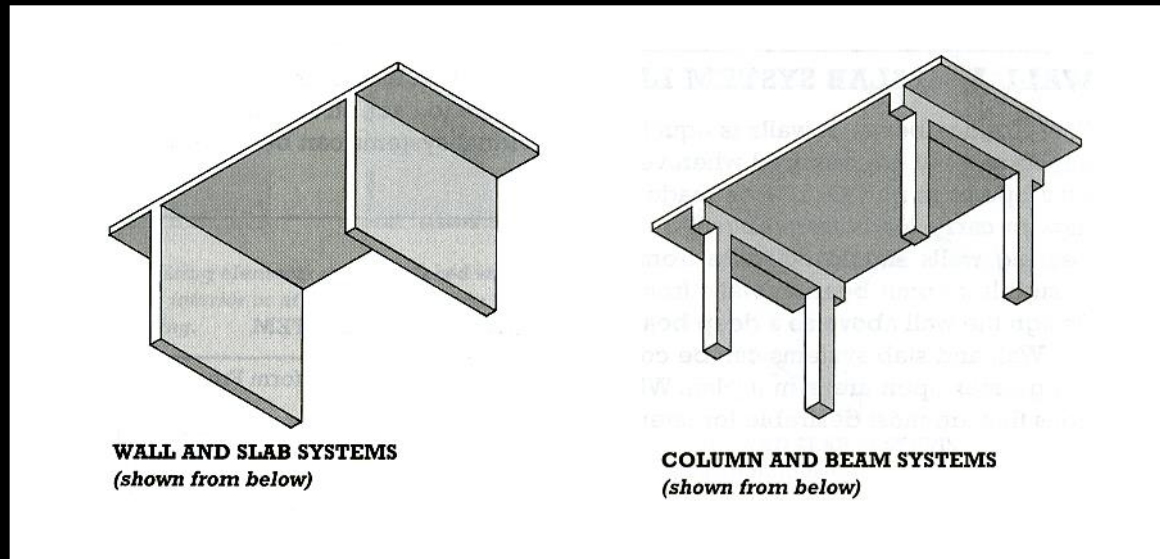

*walls*

*columns*

# Design Issues

- *lateral load resistance*

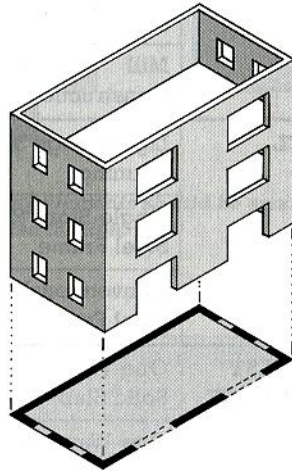

*Shear walls may be arranged in a box form to resist lateral forces from all directions.*

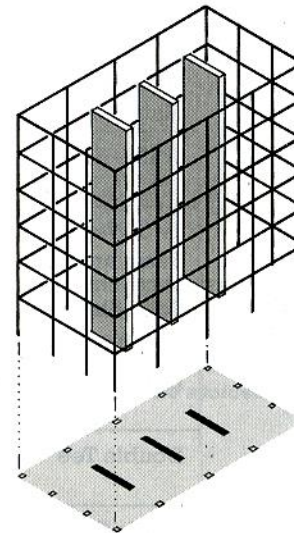

*When combined with other stabilizing mechanisms, shear walls may be arranged so as to resist forces in only one direction of a building.*

# Design Issues

- *lateral load resistance*

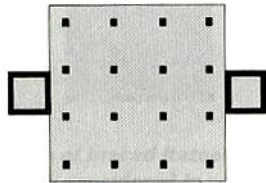
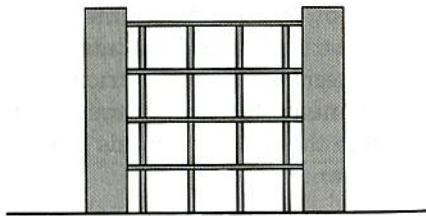

*Shear walls are commonly used with column and slab systems. In this elevation and plan, the shear walls are shown incorporated into a pair of vertical cores.*

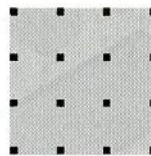
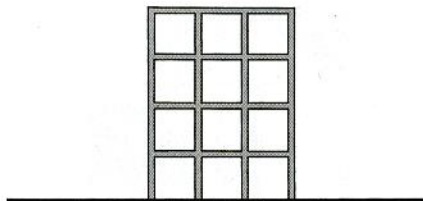

*Rigid frame structures require no additional bracing or shear walls, as shown in this elevation and plan.*

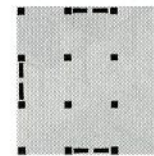
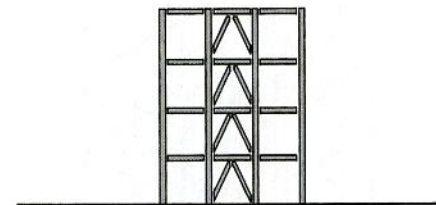

*The locations of braced frames or shear walls must be considered in relation to the elevation and plan of the building.*

# Design Issues

- *multi-story*
  - *cores, tubes, braced frames*

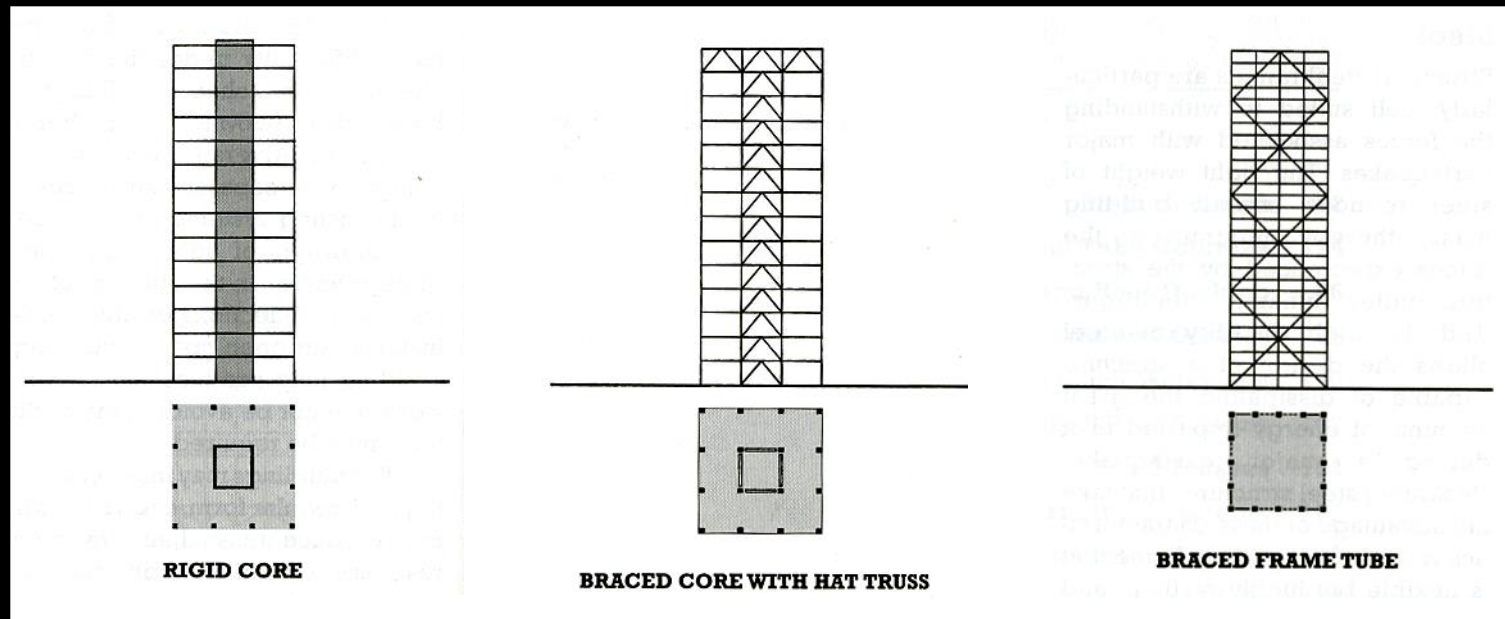



# Design Issues

- *multi-story*
  - *avoid discontinuities*
    - *vertically*
    - *horizontally*

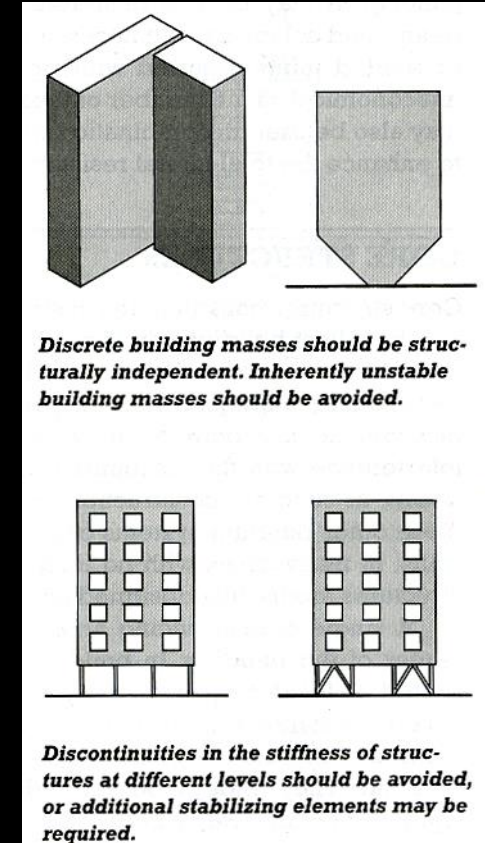
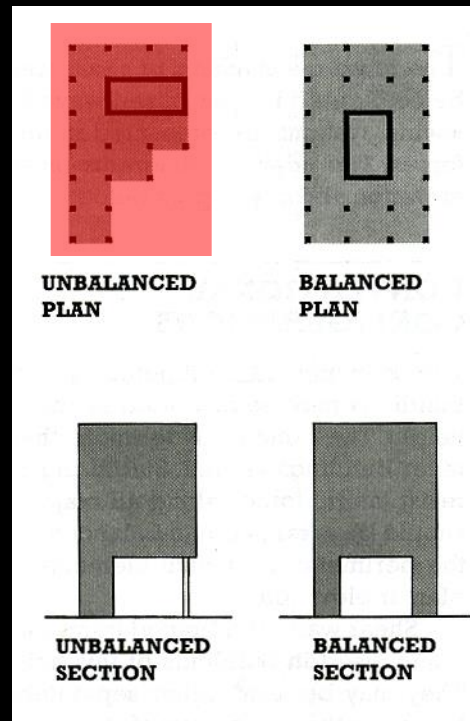
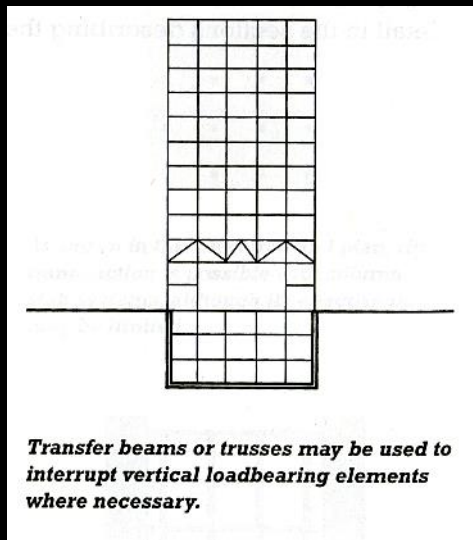

# Final Exam Material

---

- *my list:*
  - *equilibrium -  $\Sigma F$  &  $\Sigma M$* 
    - *supports, trusses, cables, beams, pinned frames, rigid frames*
  - *materials*
    - *strain & stress ( $E$ ), temperature, constraints*
  - *beams*
    - *distributed loads, tributary width, V&M, stresses, design, section properties ( $I$  &  $S$ ), pitch, deflection*

# *Final Exam Material*

---

- *my list (continued):*
  - *columns*
    - *stresses, design, section properties ( $I$  &  $r$ )*
  - *frames*
    - *$P$ ,  $V$  &  $M$ ,  $P$ - $\Delta$ , effective length with joint stiffness, connection design, tension member design*
  - *foundations*
    - *types*
    - *sizing & structural design*
    - *overturning and sliding*

# *Final Exam Material*

---

- *my list (continued):*
  - *systems*
    - *levels*
    - *design considerations*
  - *design specifics*
    - *steel (ASD & LRFD)*
    - *concrete*
    - *wood*
    - *masonry*