

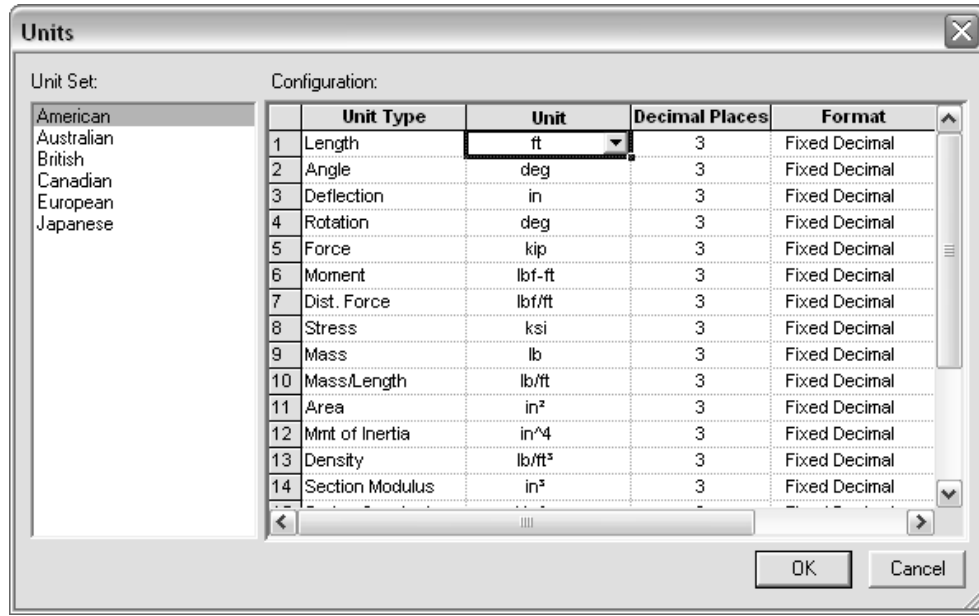

Frame Analysis Using Multiframe

1. The software is on the computers in the College of Architecture in Programs under the Windows Start menu (see <https://wikis.arch.tamu.edu/display/HELPDESK/Computer+Accounts> for lab locations). Multiframe is under the Bentley Engineering menu.
2. There are tutorials available on line at <http://www.formsys.com/mflearning> that list the tasks and order in greater detail. The first task is to define the unit system:
 - Choose Units... from the View menu. Unit sets are available, but specific units can also be selected by double clicking on a unit or format and making a selection from the menu.

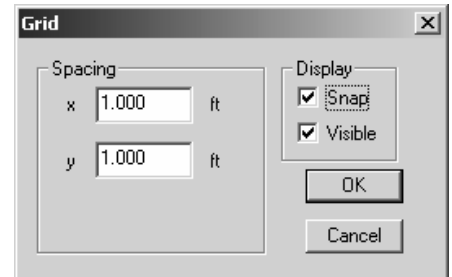

3. To see the scale of the geometry, a grid option is available:
 - Choose Grid... from the View menu



4. To create the geometry, you must be in the Frame window (default). The symbol is the frame in the window toolbar:
 

The Member toolbar shows ways to create members:

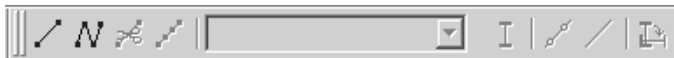

The Generate toolbar has convenient tools to create typical structural shapes.

- To create a frame, use the multi-bay frame button:



- Enter the number of bays (horizontally), number of stories (vertically) and the corresponding spacings:

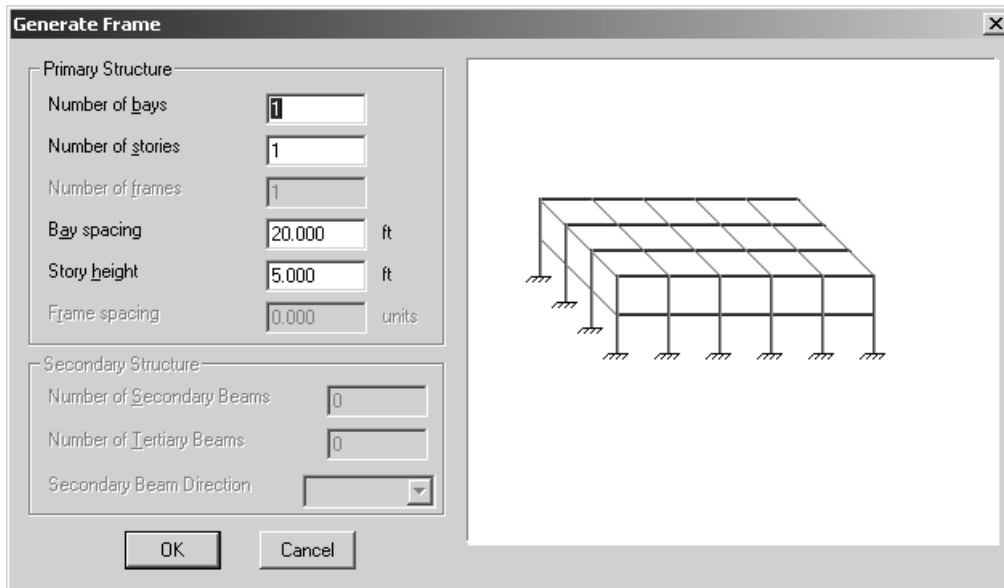

- If the frame does not have regular bays, use the add connected members button to create segments:



- Select a starting point and ending point with the cursor. The location of the cursor and the segment length is displayed at the bottom of the geometry window. The ESC button will end the segmented drawing.
- The geometry can be set precisely by selecting the joint (drag), and bringing up the joint properties menu (right click) to set the coordinates.

- The support types can be set by selecting the joint (drag) and using the Joint Toolbar (fixed shown), or the Frame / Joint Restraint ... menu (right click).

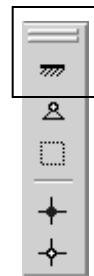

NOTE: If the support appears at both ends of the member, you had the member selected rather than the joint. Select the joint to change support for and right click to select the joint restraints menu or select the correct support on the joint toolbar.

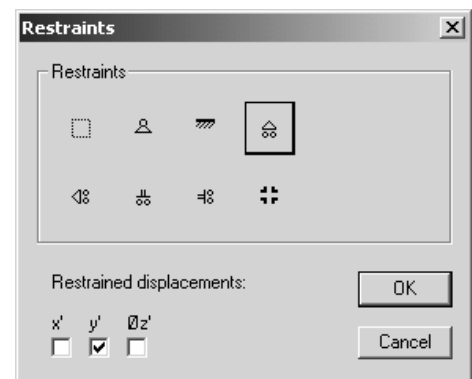

The support forces will be determined in the analysis.

5. All members must have sections assigned (see section 6.) in order to calculate reactions and deflections. To use a standard steel section **proceed to step 6.** For custom sections the section information must be entered. To define a section:

- Choose Edit Sections / Add Section... from the Edit menu
- Type a name for your new section
- Choose group Frame from the group names provided so that the section will remain with the file data
- Choose a shape. The Flat Bar shape is a rectangular section.
- Enter the cross section data.

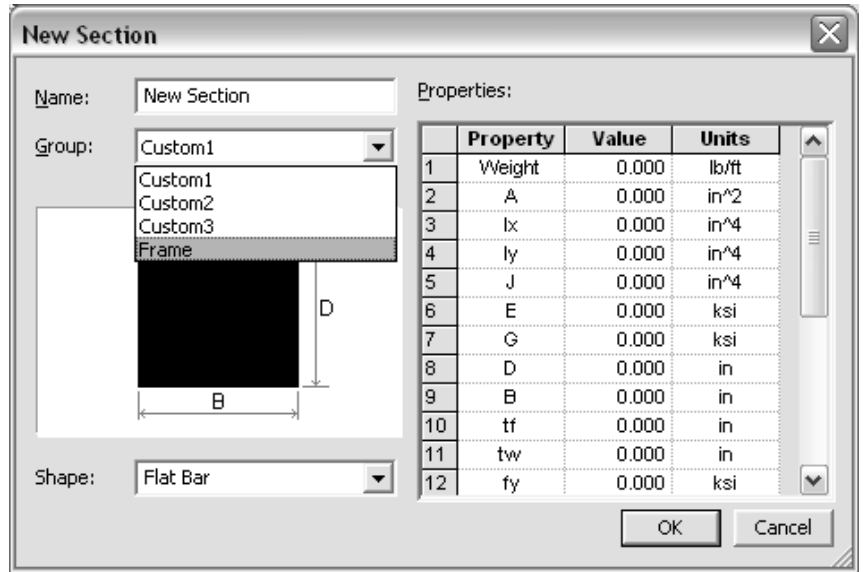

Table values 1-9 must have values for a Flat Bar, but not all are used for every analysis. A recommendation is to put the value of 1 for those properties you don't know or care about. Properties like t_f , t_w , etc. refer to wide flange sections.

- Answer any query. If the message says there is an error, the section will not be created until the error is corrected.

6. The standard sections library loaded is for the United States. If another section library is needed, use the Open Sections Library... command under the file menu, choose the library folder, and select the SectionsLibrary.slb file.

Select the members (drag to make bold) and assign sections with the Section button on the Member toolbar:



- Choose the group name and section name:

(STANDARD SHAPES)

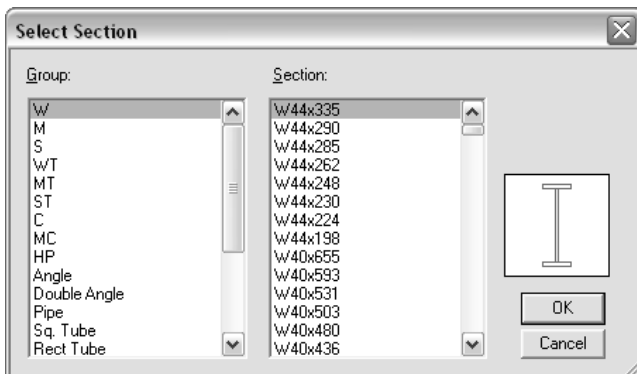

(CUSTOM)

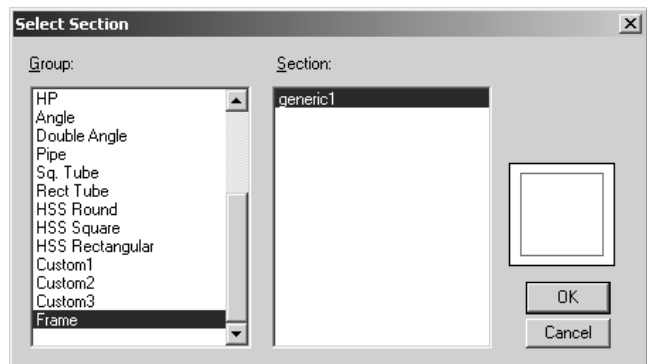

7. If there is an area that has a uniformly distributed load, load panels may be defined in the Frame window. Because the loaded area may not be visible in the current view, choose the View button at the lower left of the Frame window. The options for view are shown. (See 3D Frames, last page.)

- Choose the panel type (rectangular, 4-node, or 3-node) from the menu and select the corners. If the area is rectangular, only the opposite corners need to be selected.

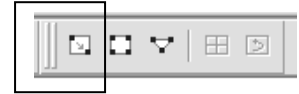

- Select the panel and from the pop-up menu, or the Frame menu, specify the load panel supports. The default supports are on all sides. If the panel is one way, chose the corresponding picture

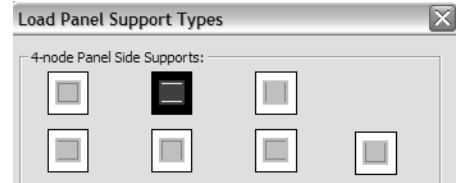

8. The frame geometry is complete, and in order to define the load conditions you must be in the Load window represented by the green arrow:



9. The Load toolbar allows a joint to be loaded with a force or a moment in global coordinates, shown by the first two buttons after the display numbers button. It allows a member to be loaded with a distributed load, concentrated load or moment (next three buttons) in global coordinates, as well as loading with distributed or single force or moment in the local coordinate system (next three buttons). It allows a load panel to be loaded with a distributed load in global or local coordinates (last two buttons).



- Choose the member to be loaded (drag) and select the load type (here shown for global distributed loading):



- Choose the distribution type and direction. Note that the arrow shown is the direction of the loading. There is no need to put in negative values for downward loading.
- Enter the values of the load and distances (if any). Distances can be entered as a function of the length , i.e. L/2, L/4...
- Area load units may have to be changed in the View Units dialogue.

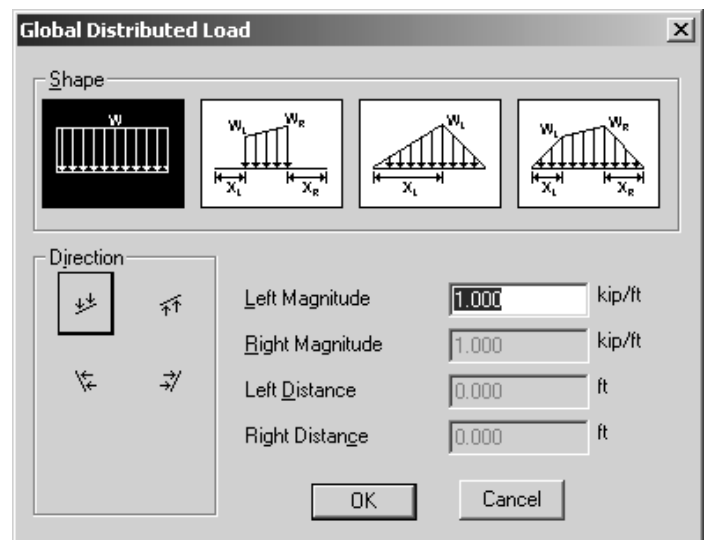

NOTE: Do not put support reactions as applied loads. The analysis will determine the reaction values.

Multiframe will automatically generate a grouping called a Load Case named Load Case 1 when a load is created. All additional loads will be added to this load case unless a new load case is defined (Add case under the Case menu).

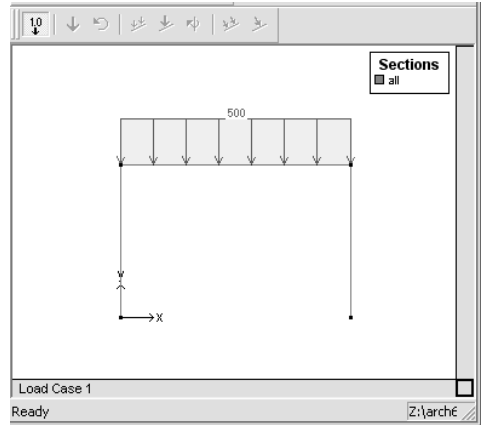

10. In order to run the analysis after the geometry, member properties and loading has been defined:

- Choose Linear from the Analyze menu

11. If the analysis is successful, you can view the results in the Plot window represented by the red moment diagram:



12. The Plot toolbar allows the numerical values to be shown (1.0 button), the reaction arrows to be shown (brown up arrow) and reaction moments to be shown (brown curved arrow):



- To show the moment diagram, Choose the red Moment button

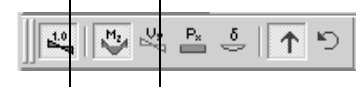

- To show the shear diagram, Choose the green Shear button

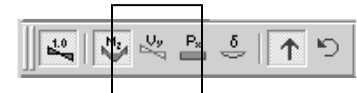

- To show the axial force diagram, Choose the purple Axial Force button

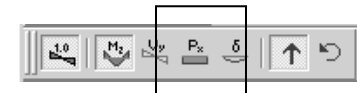

- To show the deflection diagram, Choose the blue Deflection button

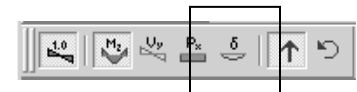

- To animate the deflection diagram, Choose Animate... from the Display menu. You can also save the animation to a .avi file by checking the box.

- To see exact values of shear, moment and deflection, double click on the member and move the vertical cross hair with the mouse. The ESC key will return you to the window.

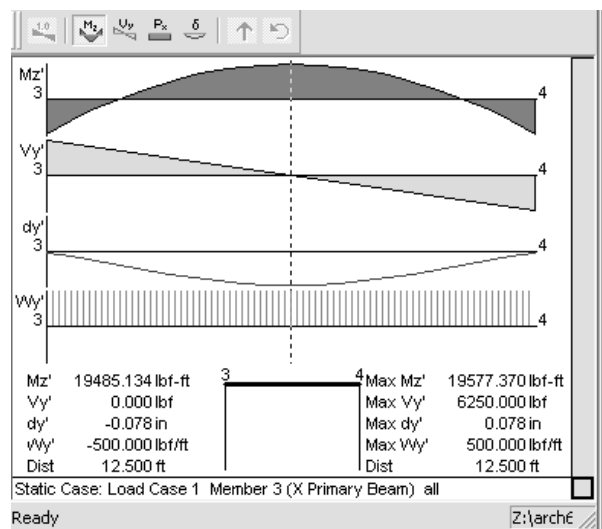

13. The Data window (D) allows you to view all data “entered” for the geometry, sections and loading. These values can be edited.



14. The Results window (R) allows you to view all results of the analysis including displacements, reactions, member forces (actions) and stresses. These values can be cut and pasted into other Windows programs such as Word or Excel.



NOTE: Px’ refers to the axial load (P) in the local axis x direction (x’). Vy’ refers to the shear perpendicular to the local x axis, and Mz’ refers to the bending moment.

	Memb	Label	Joint	Px' lbf	Vy' lbf	Mz' lbf-ft
1	1	Column	1	6250.000	-1786.320	-9725.784
2	1	Column	3	-6250.000	1786.320	-19577.371
3	2	Column	2	6250.000	1786.320	9725.784
4	2	Column	4	-6250.000	-1786.320	19577.371
5	3	X Prima	3	1786.320	6250.000	19577.371
6	3	X Prima	4	-1786.320	6250.000	-19577.371

15. To save the file Choose Save from the File menu.

16. To load an existing file Choose Open... from the File menu.

17. To print a plot Choose Print Window... from the File menu. As an alternative, you may copy the plot (Ctrl+c) and paste it in a word processing document (Ctrl+v).

Example of Combined Stresses:

for member 3: $M_{max} = 19.6 \text{ k-ft}$, $P = 1.76 \text{ k}$

knowing $A = 21.46 \text{ in}^2$, $I = 796.0 \text{ in}^4$, $c = 7.08 \text{ in}$

$$f_{max} = \frac{1.76k}{21.46in^2} + \frac{19.6^{k-ft} \cdot 7.08in}{796in^4} \cdot \frac{12in}{ft} = 0.082ksi + 2.092ksi = 2.174ksi$$

Results window:

	Memb	Label	Joint	Sbz' top ksi	Sbz' bot ksi	Sy' ksi	Sx' ksi	Sx'+Sbz' top ksi	Sx'+Sbz' bot ksi
1	1	Column	1	1.039	-1.039	-1152.461	0.286	1.325	-0.753
2	1	Column	3	-2.092	2.092	-1152.461	0.286	-1.806	2.378
3	2	Column	2	-1.039	1.039	1152.461	0.286	-0.753	1.325
4	2	Column	4	2.092	-2.092	1152.461	0.286	2.378	-1.806
5	3	X Prima	3	-2.092	2.092	4032.245	0.082	-2.011	2.174
6	3	X Prima	4	-2.092	2.092	-4032.245	0.082	-2.011	2.174

where Sx’ refers to the axial stress, Sy’ refers to the bending stress around the local vertical axis and Sz’ refers to the bending stress around the local horizontal axis.

For 3D Frames:

- There are tutorials available on line at <http://www.formsys.com/mflearning> that list the tasks and order in greater detail. It expects that you have been through the 2D tutorial to build on the steps already mastered.

- There are standard 3D frame shapes on the frame toolbar.

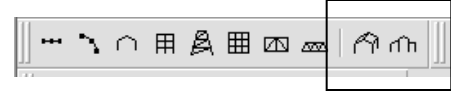

- It is very useful to change the view to isometric with the View Button

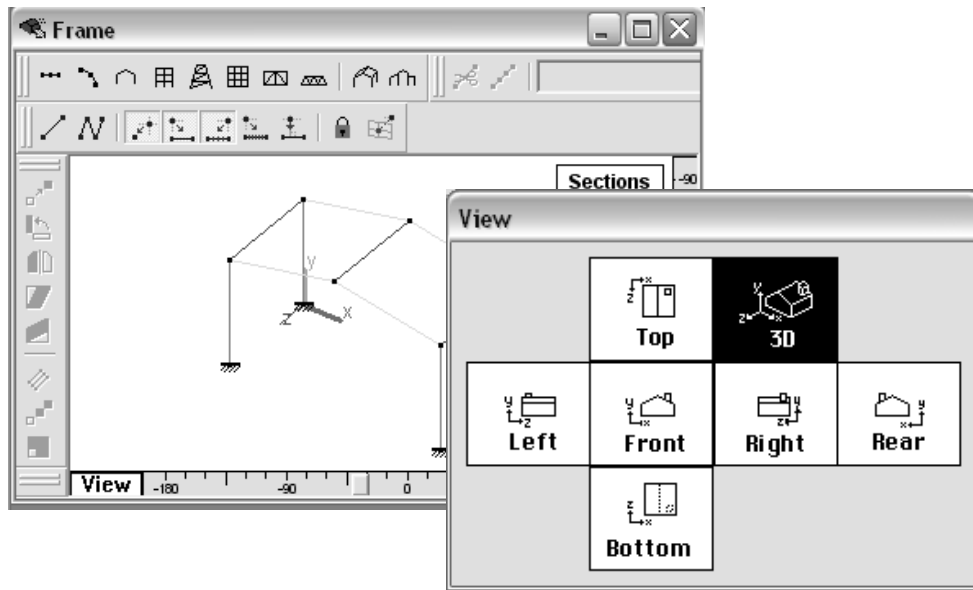

- If you wish to have additional beams supported by the beams of your frame, choose the beam and use the Subdivide Member menu under Geometry. This will make additional joints, but keep the segments together.

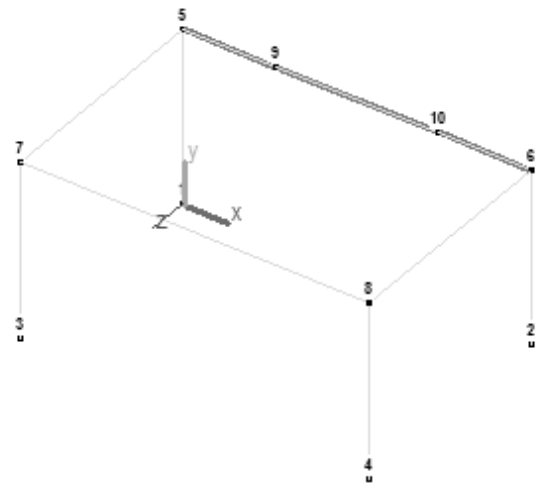
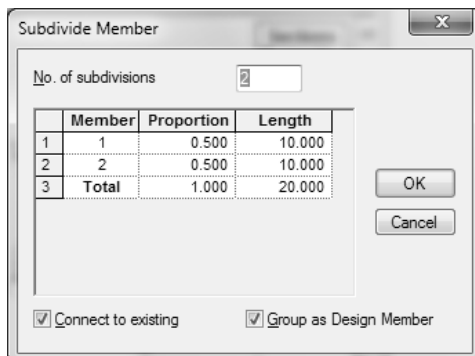

- In order to model a beam end as simply supported, you must release the restraint preventing rotation about the x-x axis of the beam. The pinned ends menu is useful for segments or subdivided members.



Or, by selecting a segment and right clicking for a menu, you can use Member Releases (also under the Frame menu) to release the Major Bending (M'_z) for one end or both.

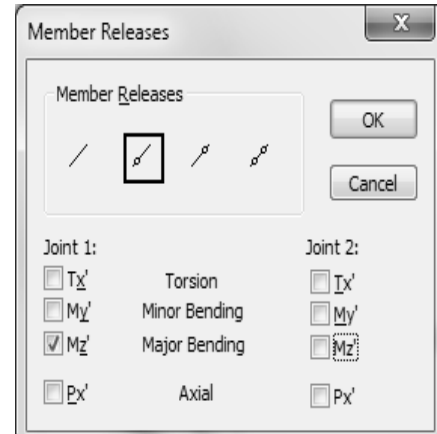

- It is necessary to understand the local member axes to assign the correct load direction. Choosing the *local* loading types will show the member orientation with respect to the load direction.

