

lecture
eighteen

steel construction:
materials & beams



Steel Beams 1
Lecture 18

Architectural Structures
ARCH 331

F2009abn

Steel Beam Design

- American Institute of Steel Construction
 - Manual of Steel Construction
 - ASD & LRFD
 - combined in 2005

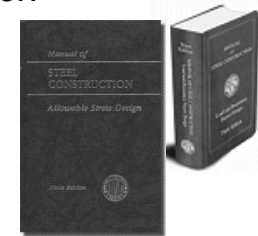
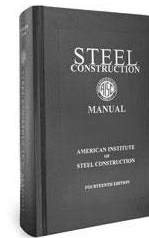

Steel Beams 2
Lecture 18

Foundations Structures
ARCH 331

F2008abn

Steel Materials

- smelt iron ore
- add alloying elements
- heat treatments
- iron, carbon
- microstructure



AISC

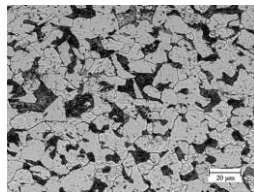

A36 steel, JOM 1998

Steel Beams 3
Lecture 18

Foundations Structures
ARCH 331

F2008abn

Steel Materials

- cast into billets
- hot rolled
- cold formed
- residual stress
- corrosion-resistant
“weathering” steels
- stainless



Hot Rolled



Cold Formed

AISC

Steel Beams 4
Lecture 18

Foundations Structures
ARCH 331

F2008abn

Steel Materials

- **steel grades**

- ASTM A36 – carbon

- plates, angles
- $F_y = 36 \text{ ksi}$ & $F_u = 58 \text{ ksi}$

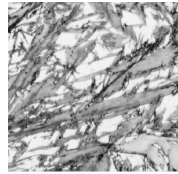

- ASTM A572 – high strength low-alloy

- some beams
- $F_y = 60 \text{ ksi}$ & $F_u = 75 \text{ ksi}$

- ASTM A992 – for building framing

- most beams
- $F_y = 50 \text{ ksi}$ & $F_u = 65 \text{ ksi}$

Steel Beams 5
Lecture 18

Foundations Structures
ARCH 331

F2008abn

Steel Properties

- high strength to weight ratio
- elastic limit – yield (F_y)
- inelastic – plastic
- ultimate strength (F_u)
- ductile
- strength sensitive to temperature
- can corrode
- fatigue

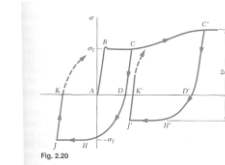
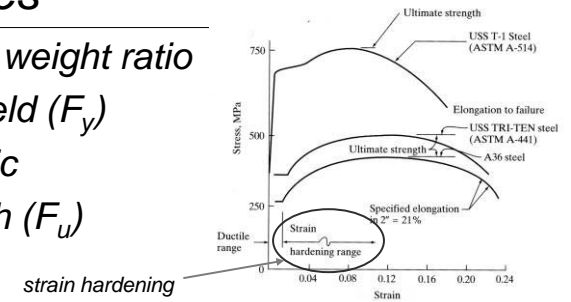

Winnipeg DOT
F2008abn

Steel Beams 6
Lecture 18

Foundations Structures
ARCH 331

Structural Steel

- standard rolled shapes (W , C , L , T)
- open web joists
- plate girders
- decking

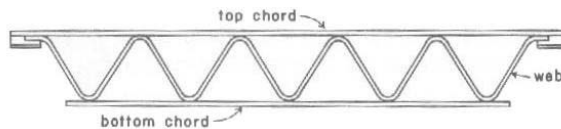
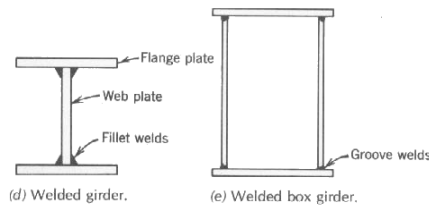
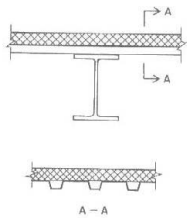

Steel Beams 7
Lecture 18

Foundations Structures
ARCH 331

F2008abn

Steel Construction

- welding
- bolts

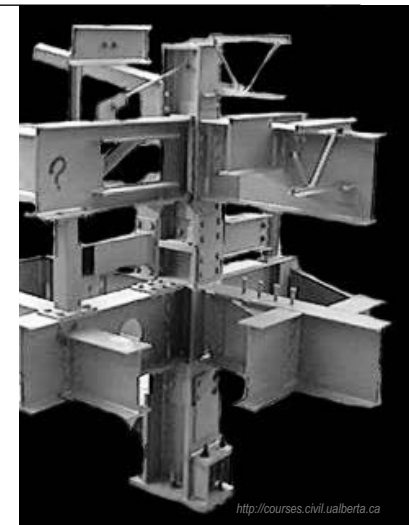
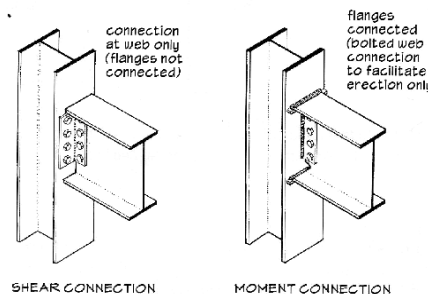

Steel Beams 8
Lecture 18

Foundations Structures
ARCH 331

F2008abn

Steel Construction

- fire proofing
 - cementitious spray
 - encasement in gypsum
 - intumescent – expands with heat
 - sprinkler system

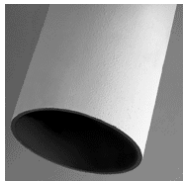

Steel Beams 9
Lecture 18

Foundations Structures
ARCH 331

F2008abn

Unified Steel Design

- braced vs. unbraced

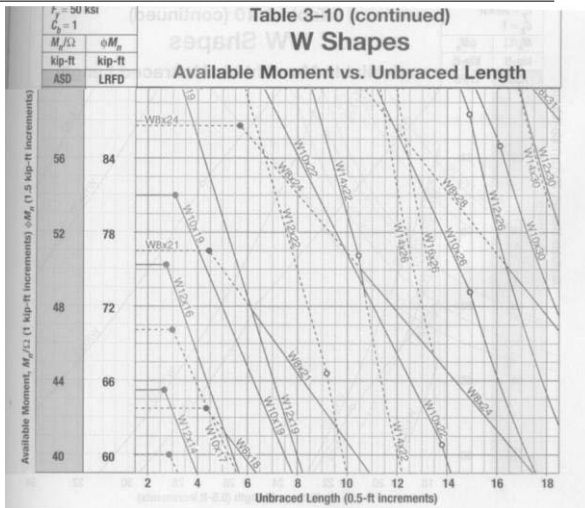

Steel Beams 11
Lecture 18

Foundations Structures
ARCH 331

F2008abn

Unified Steel Design

- ASD

$$R_a \leq \frac{R_n}{\Omega}$$

- bending (braced) $\Omega = 1.67$
- bending (unbraced*) $\Omega = 1.67$
- shear $\Omega = 1.5$ or 1.67
- shear (bolts & welds) $\Omega = 2.00$
- shear (welds) $\Omega = 2.00$

* flanges in compression can buckle

Steel Beams 10
Lecture 18

Foundations Structures
ARCH 331

F2008abn

LRFD

- loads on structures are

- not constant
- can be more influential on failure
- happen more or less often
- UNCERTAINTY

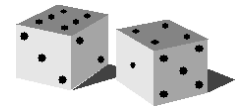

$$R_u = \gamma_D R_D + \gamma_L R_L \leq \phi R_n$$

ϕ - resistance factor

γ - load factor for (D)ead & (L)ive load

Steel Beams 12
Lecture 18

Foundations Structures
ARCH 331

F2008abn

LRFD Steel Beam Design

- limit state is yielding all across section
- outside elastic range
- load factors & resistance factors

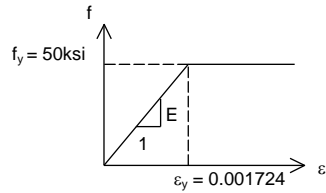
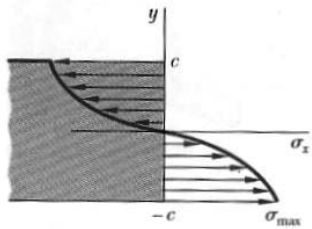

Beam Design Criteria (revisited)

- strength design
 - bending stresses predominate
 - shear stresses occur
- serviceability
 - limit deflection
 - stability
- superpositioning
 - use of beam charts
 - elastic range only!
 - “add” moment diagrams
 - “add” deflection CURVES (not maximums)

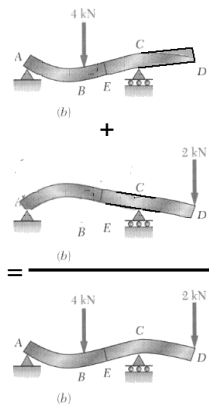

LRFD Load Combinations

ASCE-7
(2005)

- $1.4(D + F)$
- $1.2(D + F + T) + 1.6(L + H) + 0.5(L_r \text{ or } S \text{ or } R)$
- $1.2D + 1.6(L_r \text{ or } S \text{ or } R) + (L \text{ or } 0.8W)$
- $1.2D + 1.6W + L + 0.5(L_r \text{ or } S \text{ or } R)$
- $1.2D + 1.0E + L + 0.2S$
- $0.9D + 1.6W + 1.6H$
- $0.9D + 1.0E + 1.6H$

Steel Beams

- lateral stability - bracing
- local buckling – stiffen, or bigger I_y

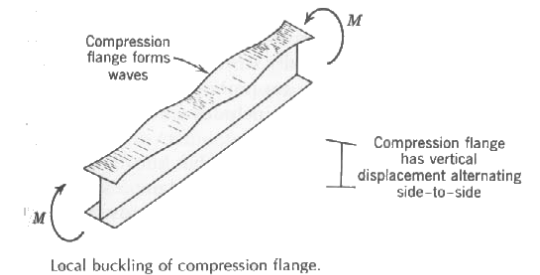
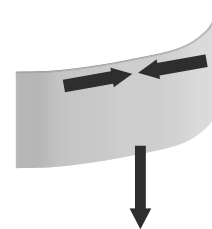

Local Buckling

- steel I beams
- flange
 - buckle in direction of smaller radius of gyration
- web
 - force
 - “crippling”

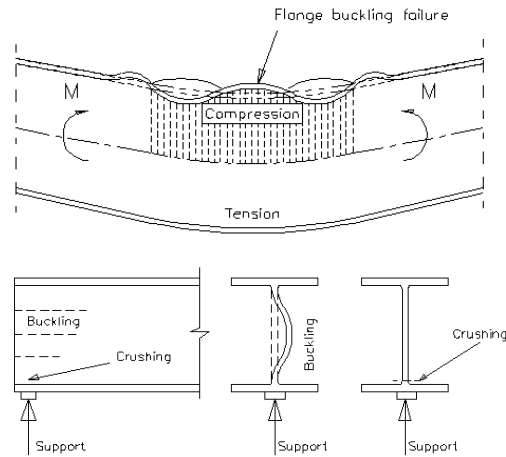

Steel Beams 17
Lecture 18

Foundations Structures
ARCH 331

F2008abn

Local Buckling

- flange

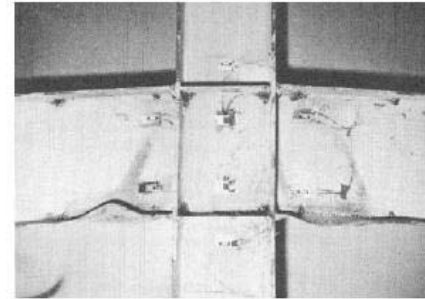

Figure 2-5. Flange Local Bending Limit State
(Beedle, L.S., Christopher, R., 1964)

- web



Figure 2-7. Web Local Buckling Limit State
(SAC Project)

Steel Beams 18
Lecture 18

Foundations Structures
ARCH 331

F2008abn

Shear in Web

- panels in plate girders or webs with large shear
- buckling in compression direction
- add stiffeners

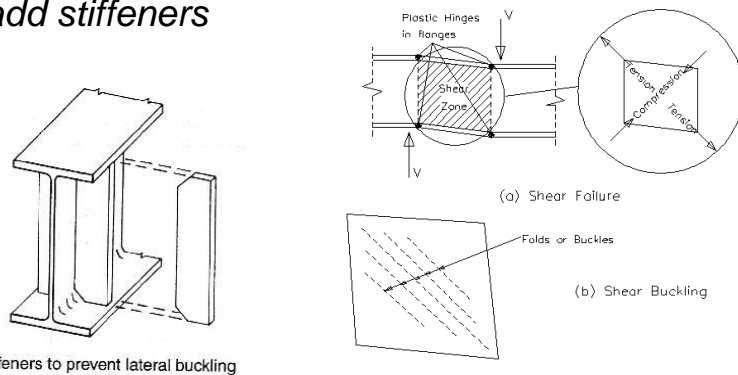

Steel Beams 19
Lecture 18

Foundations Structures
ARCH 331

F2008abn

Shear in Web

- plate girders and stiffeners



<http://nisee.berkeley.edu/godden>

Steel Beams 20
Lecture 18

Foundations Structures
ARCH 331

F2008abn

Steel Beams

- bearing
 - provide adequate area
 - prevent local yield of flange and web

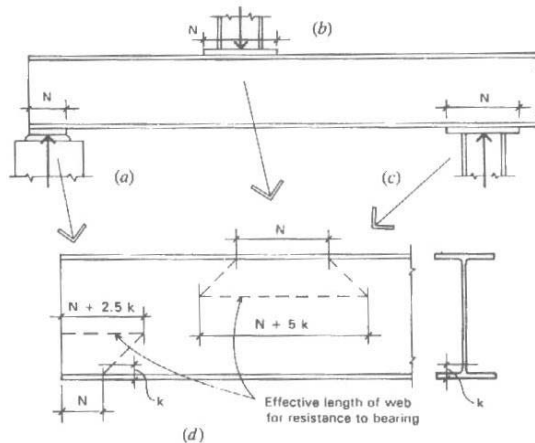

Figure 9.10 Considerations for bearing in beams with thin webs, as related to web crippling (buckling of the thin web in compression).

Steel Beams 21
Lecture 18

Foundations Structures
ARCH 331

F2008abn

LRFD - Flexure

$$\sum \gamma_i R_i = M_u \leq \phi_b M_n = 0.9 F_y Z$$

M_u - maximum moment

ϕ_b - resistance factor for bending = 0.9

M_n - nominal moment (ultimate capacity)

F_y - yield strength of the steel

Z - plastic section modulus*

Steel Beams 22
Lecture 18

Foundations Structures
ARCH 331

F2008abn

Internal Moments - at yield

- material hasn't failed

$$M_y = \frac{I}{c} f_y = \frac{bh^2}{6} f_y$$

$$= \frac{b(2c)^2}{6} f_y = \frac{2bc^2}{3} f_y$$

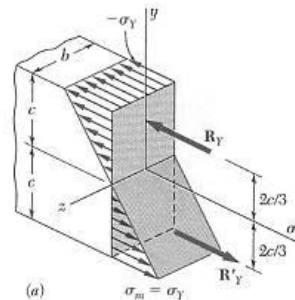

Internal Moments - ALL at yield

- all parts reach yield
- plastic hinge forms
- ultimate moment
- $A_{tension} = A_{compression}$

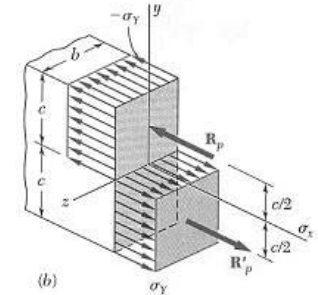

$$M_p = bc^2 f_y = \frac{3}{2} M_y$$

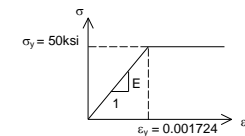

Steel Beams 23
Lecture 18

Foundations Structures
ARCH 331

F2008abn

Steel Beams 24
Lecture 18

Foundations Structures
ARCH 331

F2008abn

n.a. of Section at Plastic Hinge

- cannot guarantee at centroid
- $f_y \cdot A_1 = f_y \cdot A_2$
- moment found from yield stress times moment area

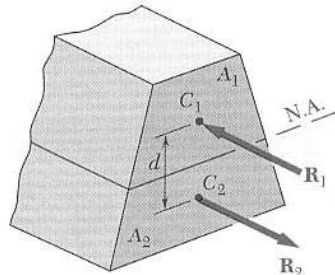

$$M_p = f_y A_1 d = f_y \sum_{n.a} A_i d_i$$

Steel Beams 25
Lecture 18

Foundations Structures
ARCH 331

F2008abn

Plastic Hinge Examples

- stability can be effected

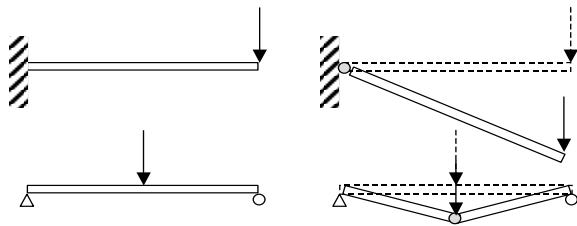

Steel Beams 27
Lecture 18

Foundations Structures
ARCH 331

F2008abn

Plastic Hinge Development

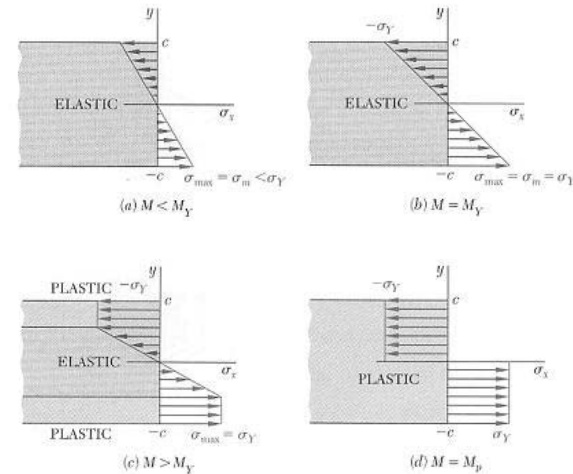

Steel Beams 26
Lecture 18

Foundations Structures
ARCH 331

F2008abn

Plastic Section Modulus

- shape factor, k

$$k = \frac{M_p}{M_y}$$

= 3/2 for a rectangle

≈ 1.1 for an I



$$k = \frac{Z}{S}$$

- plastic modulus, Z

$$Z = \frac{M_p}{f_y}$$

Steel Beams 28
Lecture 18

Foundations Structures
ARCH 331

F2008abn

LRFD – Shear (compact shapes)

$$\sum \gamma_i R_i = V_u \leq \phi_v V_n = 1.0(0.6F_{yw}A_w)$$

V_u - maximum shear

ϕ_v - resistance factor for shear = 1.0

V_n - nominal shear

F_{yw} - yield strength of the steel in the web

A_w - area of the web = $t_w d$

Compact Sections

- plastic moment can form before any buckling

- criteria

$$-\frac{b_f}{2t_f} \leq 0.38 \sqrt{\frac{E}{F_y}}$$

$$-\text{and } \frac{h_c}{t_w} \leq 3.76 \sqrt{\frac{E}{F_y}}$$

TABLE A.3 Properties of W Shapes

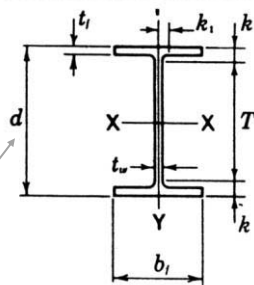

LRFD - Flexure Design

- limit states for beam failure

- yielding

$$L_p = 1.76r_y \sqrt{\frac{F_y}{E}}$$

- lateral-torsional buckling*

- flange local buckling

- web local buckling

- minimum M_n governs

$$\sum \gamma_i R_i = M_u \leq \phi_b M_n$$

Lateral Torsional Buckling

$$M_n = C_b \left[\begin{array}{l} \text{moment based on} \\ \text{lateral buckling} \end{array} \right] \leq M_p$$

$$C_b = \frac{12.5M_{max}}{2.5M_{max} + 3M_A + 4M_B + 3M_C}$$

C_b = modification factor

M_{max} - |max moment|, unbraced segment

M_A - |moment|, 1/4 point

M_B = |moment|, center point

M_C = |moment|, 3/4 point

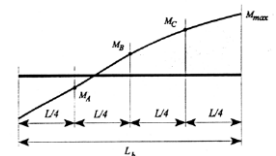

Beam Design Charts

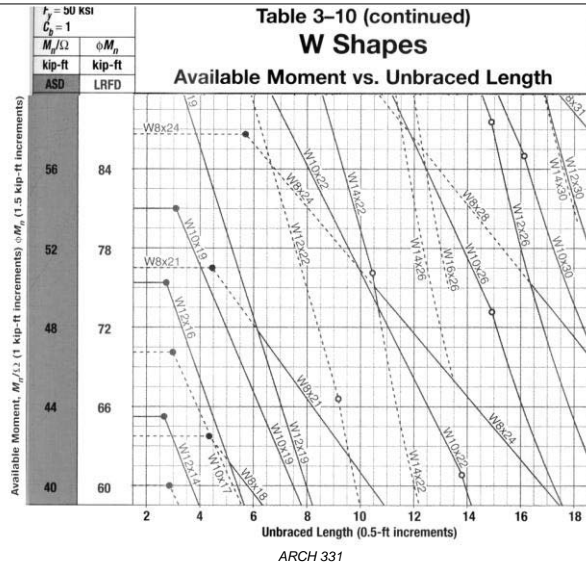

Steel Beams :
Lecture 15

Su2011abr

Charts & Deflections

- beam charts
 - solid line is most economical
 - dashed indicates there is another more economical section
 - self weight is NOT included in M_n
- deflections
 - no factors are applied to the loads
 - often governs the design

Steel Beams 34
Lecture 18

Foundations Structures
ARCH 331

F2008abn

Design Procedure (revisited)

1. Know unbraced length, material, design method (Ω , ϕ)
2. Draw V & M , finding M_{max}
3. Calculate $Z_{req'd}$ ($M_a \leq M_n/\Omega$)
($M_u \leq \phi_b M_n$)
4. Choose (economical) section from section or beam capacity charts

Steel Beams 35
Lecture 15

Foundations Structures
ARCH 331

Su2011abr

Beam Charts by S_x (Appendix A)

Table 11 Listing of W Shapes in Descending Order of S_x for Beam Design.

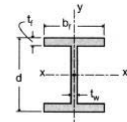

Allowable Stress Design—Selected Beam Shapes					
S_x			S_x		S_x
S_x —US (in. ³)	Section	S_x —SI (10 ³ × mm ³)	S_x —US (in. ³)	Section	S_x —SI (10 ³ × mm ³)
448	W33 × 141	7350	188	W18 × 97	3080
439	W36 × 135	7200			
411	W27 × 146	6740	176	W24 × 76	2890
			175	W16 × 100	2870
406	W33 × 130	6660	173	W14 × 109	2840
380	W30 × 132	6230	171	W21 × 83	2800
371	W24 × 146	6080	166	W18 × 86	2720
			157	W14 × 99	2570
359	W33 × 118	5890	155	W16 × 89	2540
355	W30 × 124	5820			
			154	W24 × 68	2530
329	W30 × 116	5400	151	W21 × 73	2480
329	W24 × 131	5400	146	W18 × 76	2390
329	W21 × 147	5400	143	W14 × 90	2350
299	W30 × 108	4900	140	W21 × 68	2300
299	W27 × 114	4900	134	W16 × 77	2200

St
Le

bn

Beam Charts by Z_x

TABLE 9.1 Load Factor Resistance Design Selection for Shapes Used as Beams

Designation	Z_x in. ³	$F_y = 36$ ksi				$F_y = 50$ ksi				r_x in.	$b_f/2t_f$	h/t_w	X_1 ksi	$X_2 \times 10^6$ (1/ksi) ²
		L_p ft	L_r ft	M_p kip-ft	M_r kip-ft	L_p ft	L_r ft	M_p kip-ft	M_r kip-ft					
W 33 x 141	514	10.1	30.1	1,542	971	8.59	23.1	2,142	1,493	2.43	6.01	49.6	1,800	17,800
W 30 x 148	500	9.50	30.6	1,500	945	8.06	22.8	2,083	1,453	2.28	4.44	41.6	2,310	6,270
W 24 x 162	468	12.7	45.2	1,404	897	10.8	32.4	1,950	1,380	3.05	5.31	30.6	2,870	2,260
W 24 x 146	418	12.5	42.0	1,254	804	10.6	30.6	1,742	1,237	3.01	5.92	33.2	2,590	3,420
W 33 x 118	415	9.67	27.8	1,245	778	8.20	21.7	1,729	1,197	2.32	7.76	54.5	1,510	37,700
W 30 x 124	408	9.29	28.2	1,224	769	7.88	21.5	1,700	1,183	2.23	5.65	46.2	1,930	13,500
W 21 x 147	373	12.3	46.4	1,119	713	10.4	32.8	1,554	1,097	2.95	5.44	26.1	3,140	1,590
W 24 x 131	370	12.4	39.3	1,110	713	10.5	29.1	1,542	1,097	2.97	6.70	35.6	2,330	5,290
W 18 x 158	356	11.4	56.5	1,068	672	9.69	38.0	1,483	1,033	2.74	3.92	19.8	4,410	403
W 30 x 108	346	8.96	26.3	1,038	648	7.60	20.3	1,442	997	2.15	6.89	49.6	1,680	24,200
W 27 x 114	343	9.08	28.2	1,029	648	7.71	21.3	1,429	997	2.18	5.41	42.5	2,100	9,220
W 24 x 117	327	12.3	37.1	981	631	10.4	27.9	1,363	970	2.94	7.53	39.2	2,090	8,190
W 21 x 122	307	12.2	41.0	921	592	10.3	29.8	1,279	910	2.92	6.45	31.3	2,630	3,160
W 18 x 130	290	11.3	47.7	870	555	9.55	32.8	1,208	853	2.7	4.65	23.9	3,680	810
W 30 x 90	283	8.71	24.8	849	531	7.39	19.4	1,179	817	2.09	8.52	57.5	1,410	49,600
W 24 x 103	280	8.29	27.0	840	531	7.04	20.0	1,167	817	1.99	4.59	39.2	2,390	5,310
W 27 x 94	278	8.83	25.9	834	527	7.50	19.9	1,158	810	2.12	6.70	49.5	1,740	19,900
W 14 x 145	260	16.6	81.6	780	503	14.1	54.7	1,083	773	3.98	7.11	16.8	4,400	348
W 24 x 94	254	8.25	23.9	762	481	7.00	19.4	1,058	740	1.98	5.18	41.9	2,180	7,800

Steel Beams 37
Lecture 18

Foundations Structures
ARCH 331

F2011abn

Beam Design (revisited)

6. Evaluate shear stresses - horizontal

- $(V_a \leq V_n/\Omega)$ or $(V_u \leq \phi V_n)$

- rectangles and W's $f_{v-max} = \frac{3V}{2A} \approx \frac{V}{A_{web}}$

$$V_n = 0.6 F_{yw} A_w$$

- general $f_{v-max} = \frac{VQ}{Ib}$

Steel Beams 38
Lecture 15

Foundations Structures
ARCH 331

Su2011abn

Beam Design (revisited)

4*. Include self weight for M_{max}

- it's dead load
- and repeat 3 & 4 if necessary

5. Consider lateral stability

Unbraced roof trusses were blown down in 1999 at this project in Moscow, Idaho.

Photo: Ken Carper

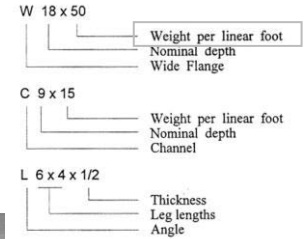

Steel Beams 37
Lecture 15

Foundations Structures
ARCH 331

Su2011abn

Beam Design (revisited)

7. Provide adequate bearing area at supports $(P_a \leq P_n/\Omega)$ $(P_u \leq \phi P_n)$

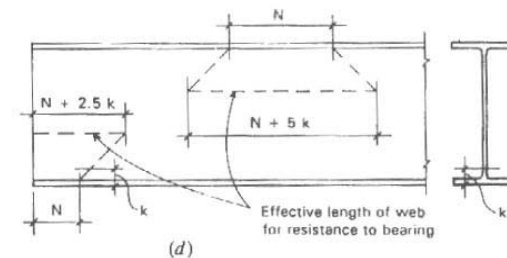

Steel Beams 39
Lecture 18

Foundations Structures
ARCH 331

F2008abn

Beam Design (revisited)

8. Evaluate torsion

$$(f_v \leq F_v)$$

- circular cross section

$$f_v = \frac{T\rho}{J}$$

- rectangular

$$f_v = \frac{T}{c_1 ab^2}$$

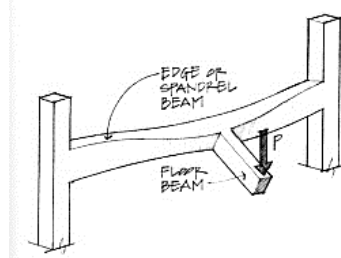
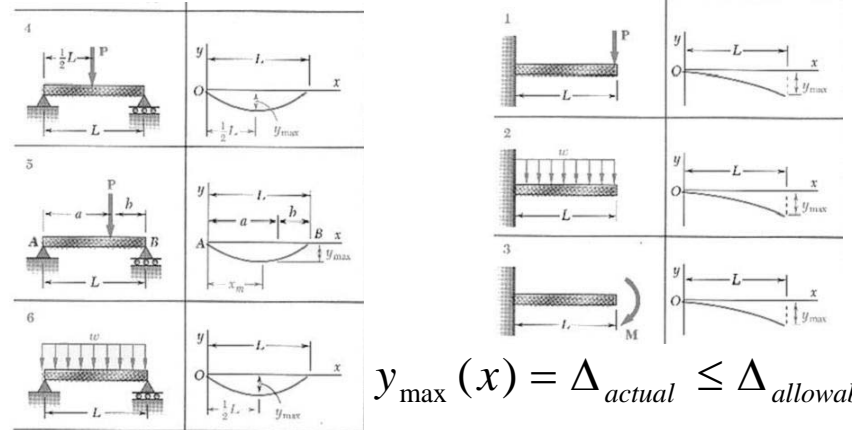

TABLE 3.1. Coefficients for Rectangular Bars in Torsion

a/b	c ₁	c ₂
1.0	0.208	0.1406
1.2	0.219	0.1661
1.5	0.231	0.1958
2.0	0.246	0.229
2.5	0.258	0.249
3.0	0.267	0.263
4.0	0.282	0.281
5.0	0.291	0.291
10.0	0.312	0.312
∞	0.333	0.333

Beam Design (revisited)

9. Evaluate deflections – NO LOAD FACTORS



$$y_{\max}(x) = \Delta_{\text{actual}} \leq \Delta_{\text{allowable}}$$

Load Tables & Equivalent Load

- uniformly distributed loads

- equivalent "w" $M_{\max} = \frac{w_{\text{equivalent}} L^2}{8}$

LRFD

STANDARD LOAD TABLE FOR OPEN WEB STEEL JOISTS, K-SERIES
Based On A 50 ksi Maximum Yield Strength - Loads Shown in Pounds Per Linear Foot (plf)

Joist Designation	10K1	12K1	12K3	12K5	14K1	14K3	14K4	14K6	16K2	16K3	16K4	16K5	16K6	16K7	16K9
Depth (in.)	10	12	12	12	14	14	14	14	16	16	16	16	16	16	16
Approx. Wt (lb/ft)	5.0	5.0	5.7	7.1	5.2	6.0	6.7	7.7	5.5	6.3	7.0	7.5	8.1	8.6	10.0
Span (ft.)															
10	825														
11	825														
12	825	825	825	825											
13	716	825	825	825											
14	353	510	510	510											
15	537	651	814	825	796	825	825	825	825	825	825	825	825	825	825
16	468	570	714	825	672	825	825	825	825	825	825	825	825	825	825
17	415	504	630	825	592	742	825	825	768	825	825	825	825	825	825
18	369	448	561	760	528	661	795	825	684	762	825	825	825	825	825
19	331	402	502	681	472	592	712	825	612	682	820	825	825	825	825
20	298	361	453	613	426	534	642	787	552	615	739	825	825	825	825
21	271	327	409	565	385	483	582	712	499	556	670	754	822	825	825
22	248	303	373	505	351	439	529	648	454	505	609	687	747	825	825
23	229	274	340	462	321	402	483	592	415	462	566	637	697	760	825
24	211	251	311	411	291	361	431	511	371	411	491	551	611	661	721

load for live load deflection limit
in RED, total in BLACK

Sloped Beams

- stairs & roofs
- projected live load
- dead load over length

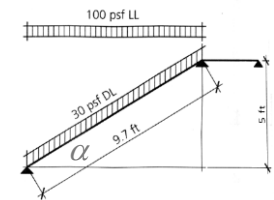

- perpendicular load to beam:

$$w_{\perp} = w \cdot \cos \alpha$$

- equivalent distributed load:

$$w_{\text{adj.}} = \frac{w}{\cos \alpha}$$

Steel Arches and Frames

- solid sections or open web

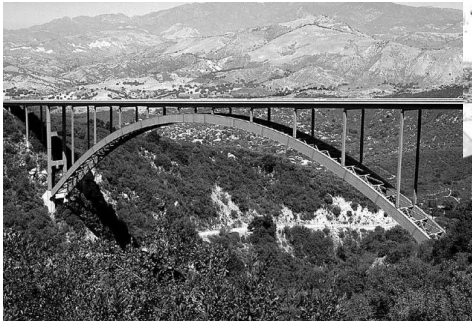

<http://nisee.berkeley.edu/godden>



Freedom Steel

Steel Beams 44
Lecture 18

Foundations Structures
ARCH 331

F2008abn

Steel Shell and Cable Structures



Steel Beams 45
Lecture 18

Foundations Structures
ARCH 331

F2008abn

Approximate Depths

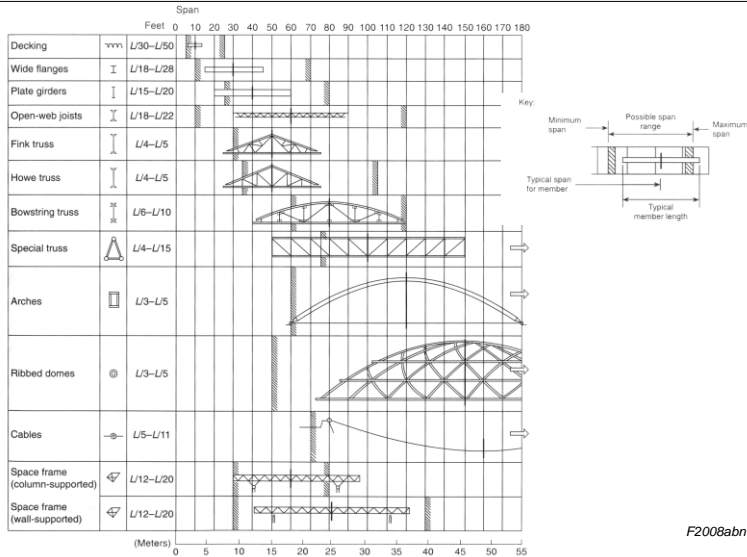

Steel Beams
Lecture

F2008abn