

**ARCHITECTURAL STRUCTURES:
FORM, BEHAVIOR, AND DESIGN**

ARCH 331

DR. ANNE NICHOLS

FALL 2013

**lecture
four**



<http://nisee.berkeley.edu/godden>

**point equilibrium
and planar trusses**

Equilibrium

- *balanced*
- *steady*
- *resultant of forces on a particle is 0*

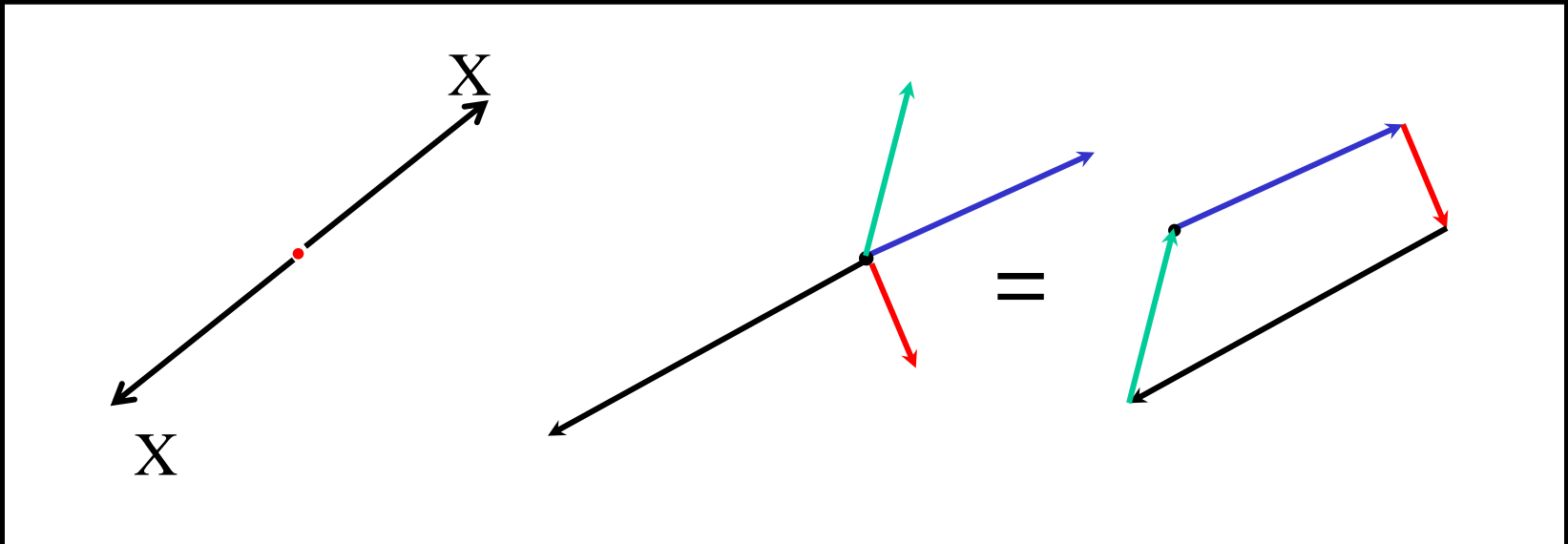

Equilibrium on a Point

- analytically

$$R_x = \sum F_x = 0$$

$$R_y = \sum F_y = 0$$

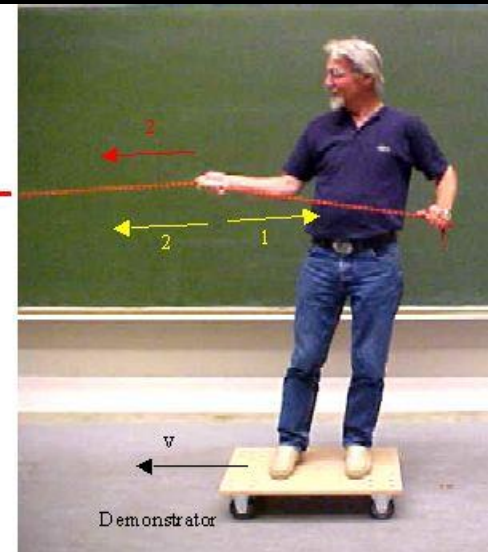
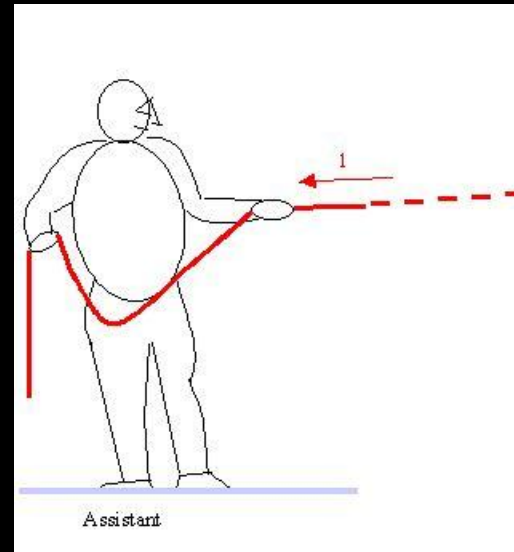

<http://www.physics.umd.edu>

- Newton convinces us it will stay at rest

Equilibrium on a Point

- *collinear force system*

– *ex: cables*

$$\sum F_{in-line} = 0$$

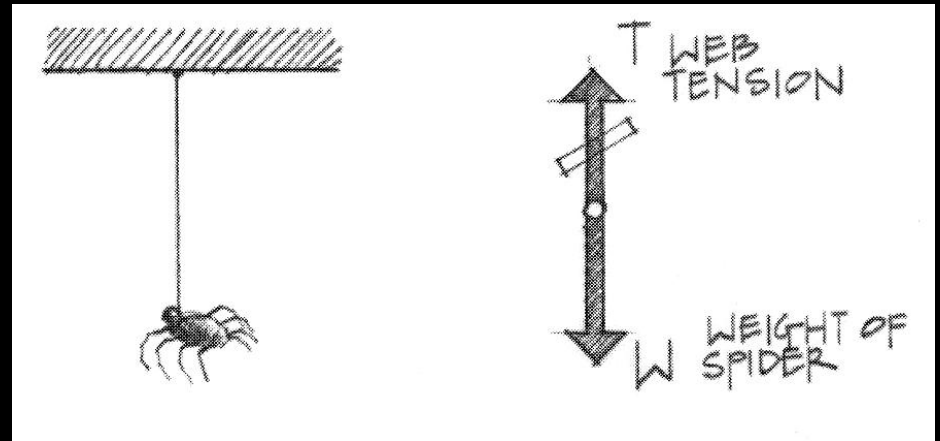

$$\left[R_x = \sum F_x = 0 \quad R_y = \sum F_y = 0 \right]$$

Equilibrium on a Point

- *concurrent force system*
 - *ex: cables*

$$R_x = \sum F_x = 0$$

$$R_y = \sum F_y = 0$$

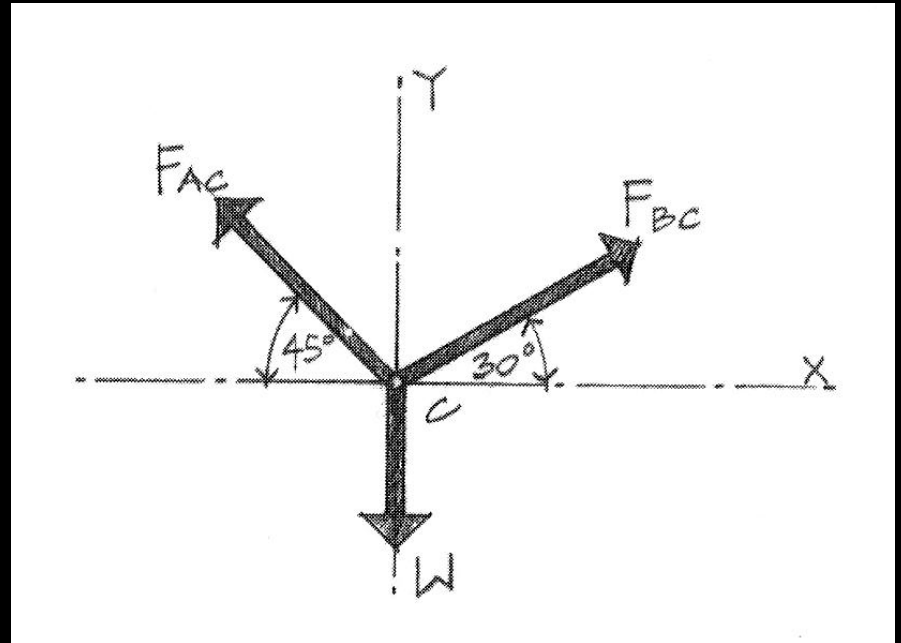

Free Body Diagram

- *FBD (sketch)*
- *tool to see all forces on a body or a point including*
 - *external forces*
 - *weights*
 - *force reactions*
 - *internal forces*

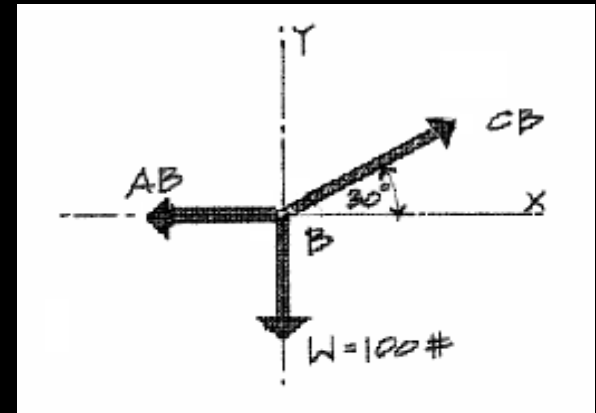

Free Body Diagram

- determine point
- FREE it from:
 - ground
 - supports & connections
- draw all external forces acting ON the body
 - reactions (supporting forces)
 - applied forces
 - gravity

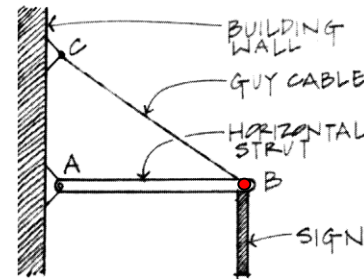

Sign suspended from a strut and cable.

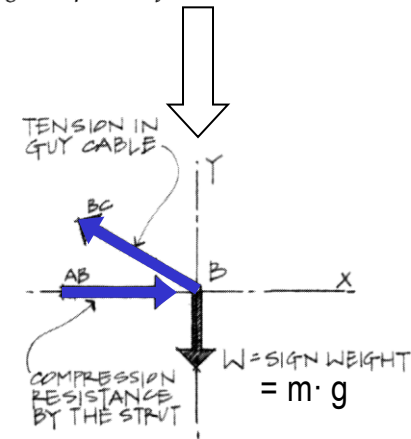

FBD of concurrent point B.

Free Body Diagram

- *sketch FBD with relevant geometry*
- *resolve each force into components*
 - *known & unknown angles – name them*
 - *known & unknown forces – name them*
- *are any forces related to other forces?*
- *for the unknowns*
- *write only as many equilibrium equations as needed*
- *solve up to 2 equations*

Free Body Diagram

- *solve equations*
 - *most times 1 unknown easily solved*
 - *plug into other equation(s)*

- *common to have unknowns of*
 - *force magnitudes*
 - *force angles*

Truss Structures

- *ancient (?) wood*
 - *Romans 500 B.C.*
- *Renaissance revival*
- *1800's analysis*
- *efficient*

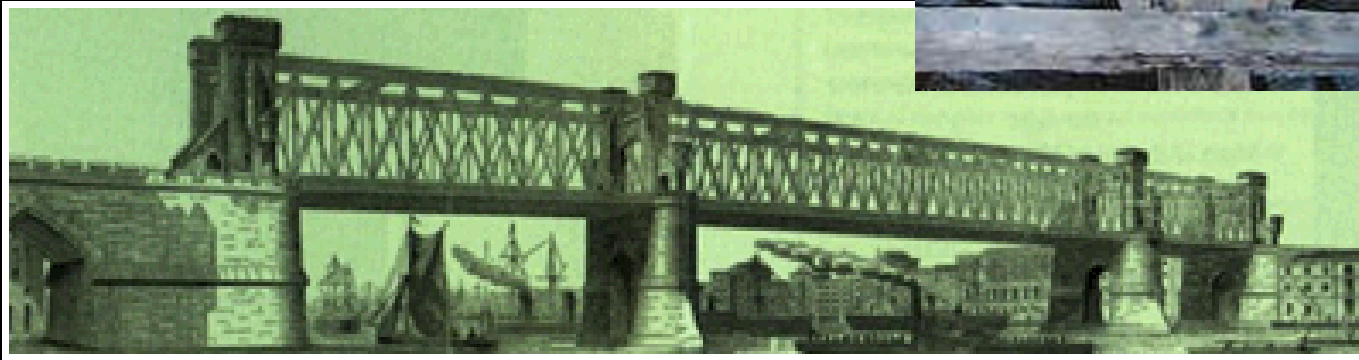

Truss Structures

– analogous to cables and struts

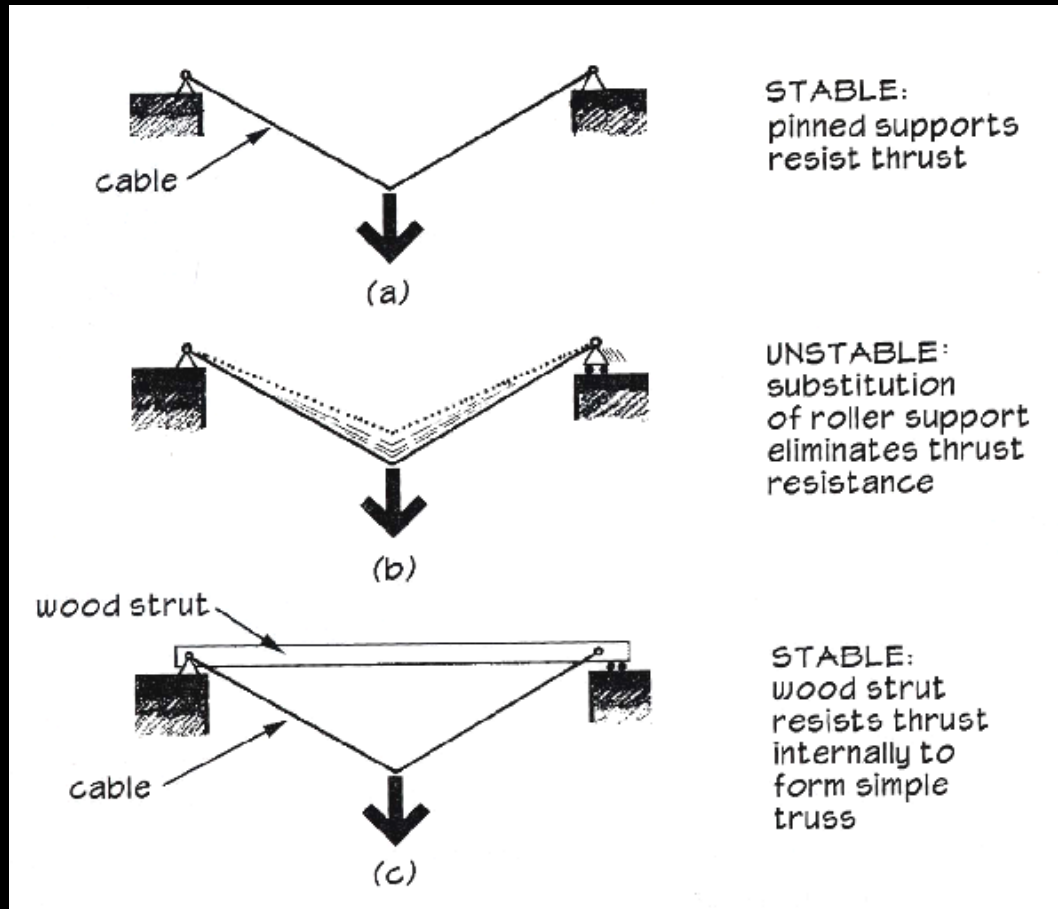

Truss Structures

- *comprised of straight members*
- *geometry with triangles is stable*
- *loads applied only at pin joints*

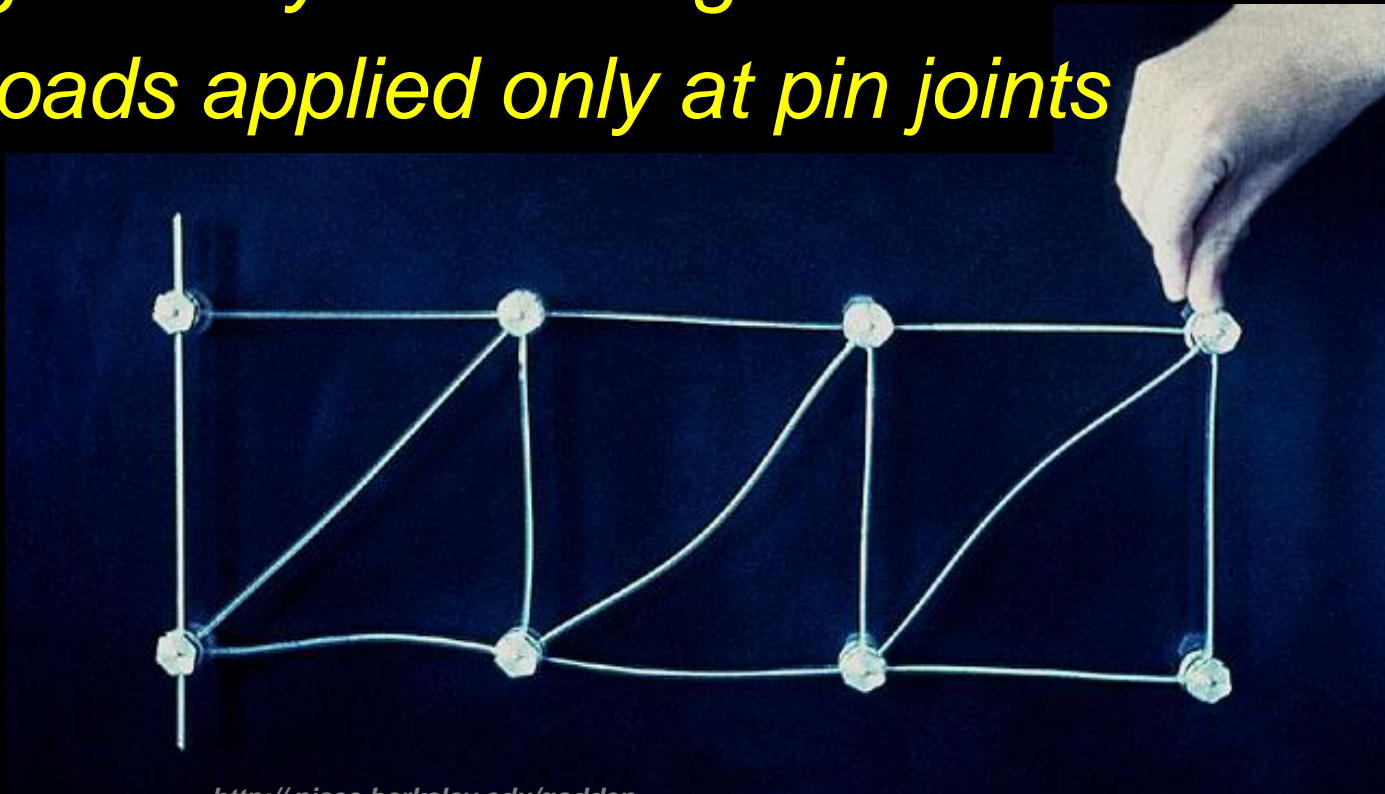

<http://nisee.berkeley.edu/godden>

Truss Structures

- *2 force members*
 - *forces in line, equal and opposite*
 - *compression*
 - *tension*

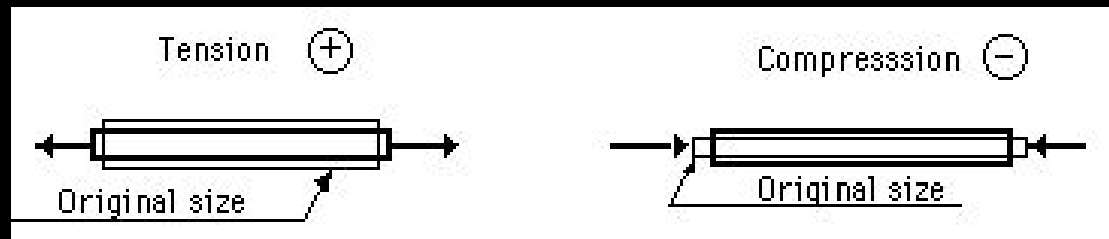

- *3 members connected by 3 joints*
- *2 more members need 1 more joint* $b = 2n - 3$

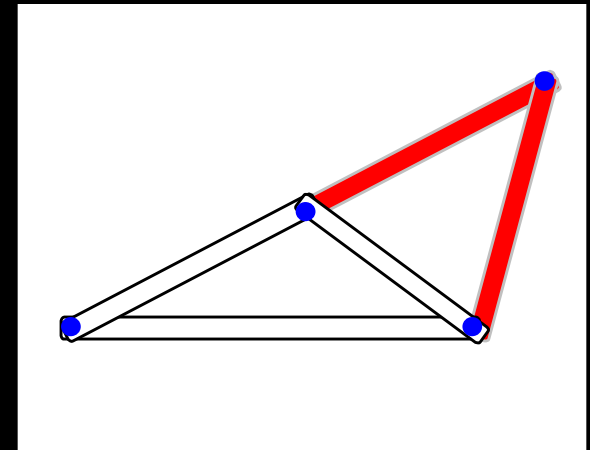

Truss Structures

- *compression and tension*

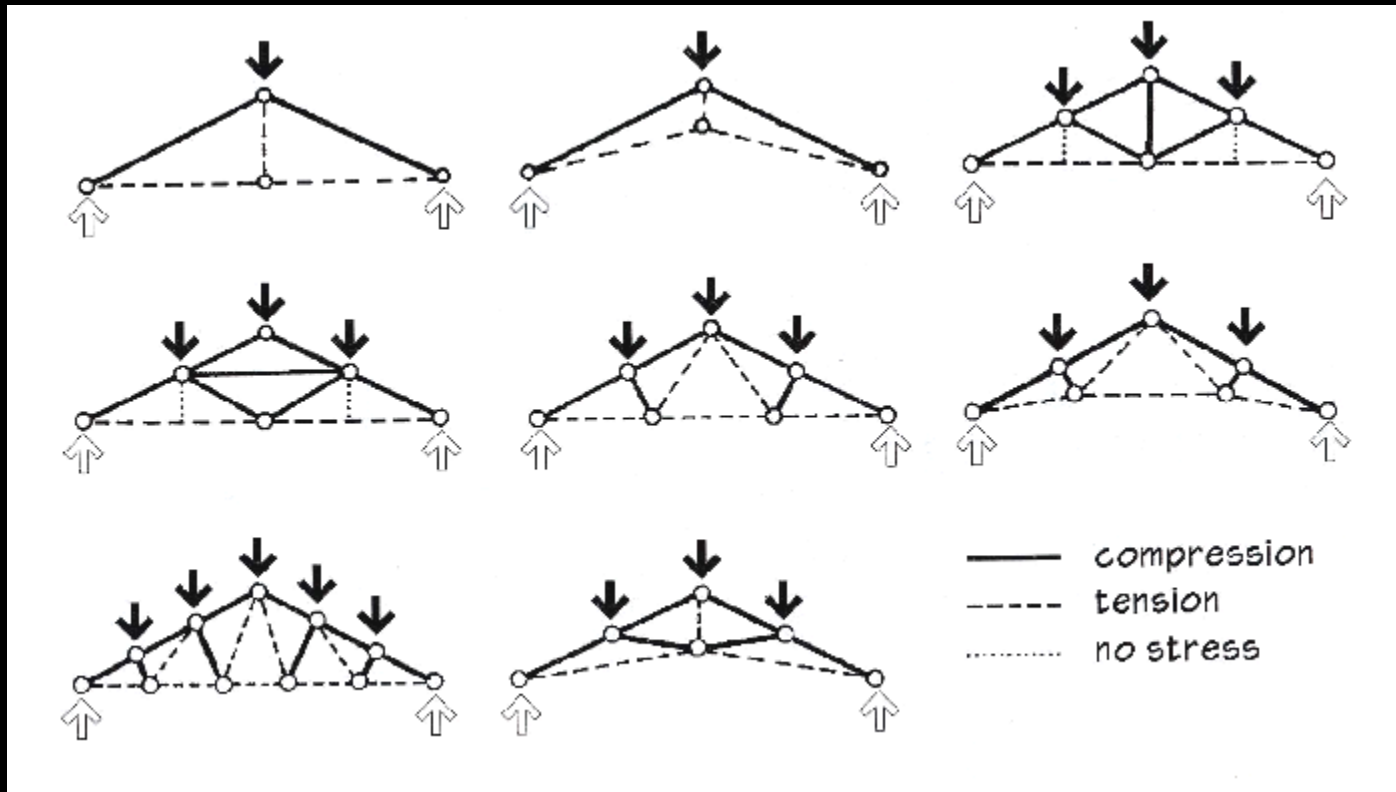

Truss Structures

- *statically determinate*
- *indeterminate*
- *unstable*

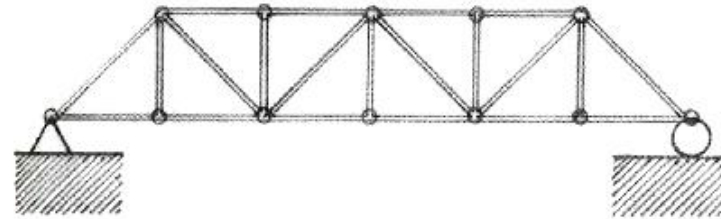

$b = 21$

$n = 12 \quad 2(n) - 3 = 2(12) - 3 = 21$

(a) *Determinate.*

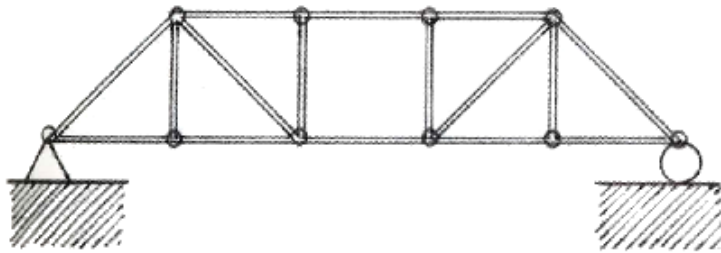

$b = 16$

$n = 10 \quad b = 16 < 2(10) - 3 = 17$

(Too few members—square panel is unstable)

(c) *Unstable.*

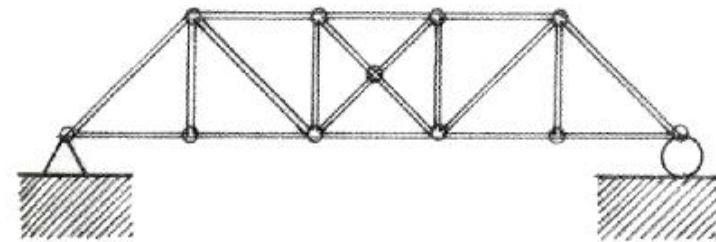

$b = 18$

$n = 10 \quad b = 18 > 2(10) - 3 = 17$

(Too many members)

(b) *Indeterminate.*

Trusses

- *common designs*

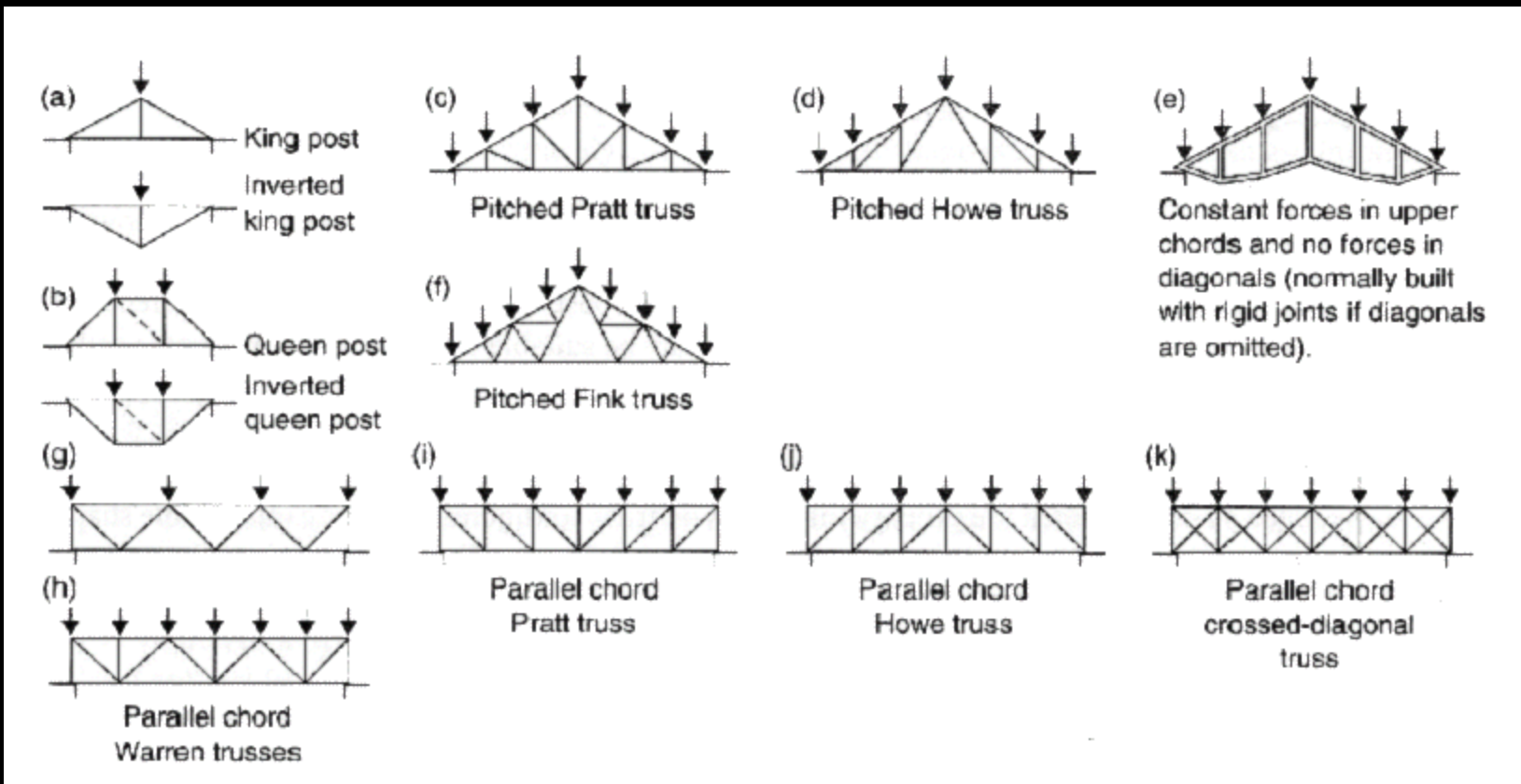

Trusses

- *common designs*

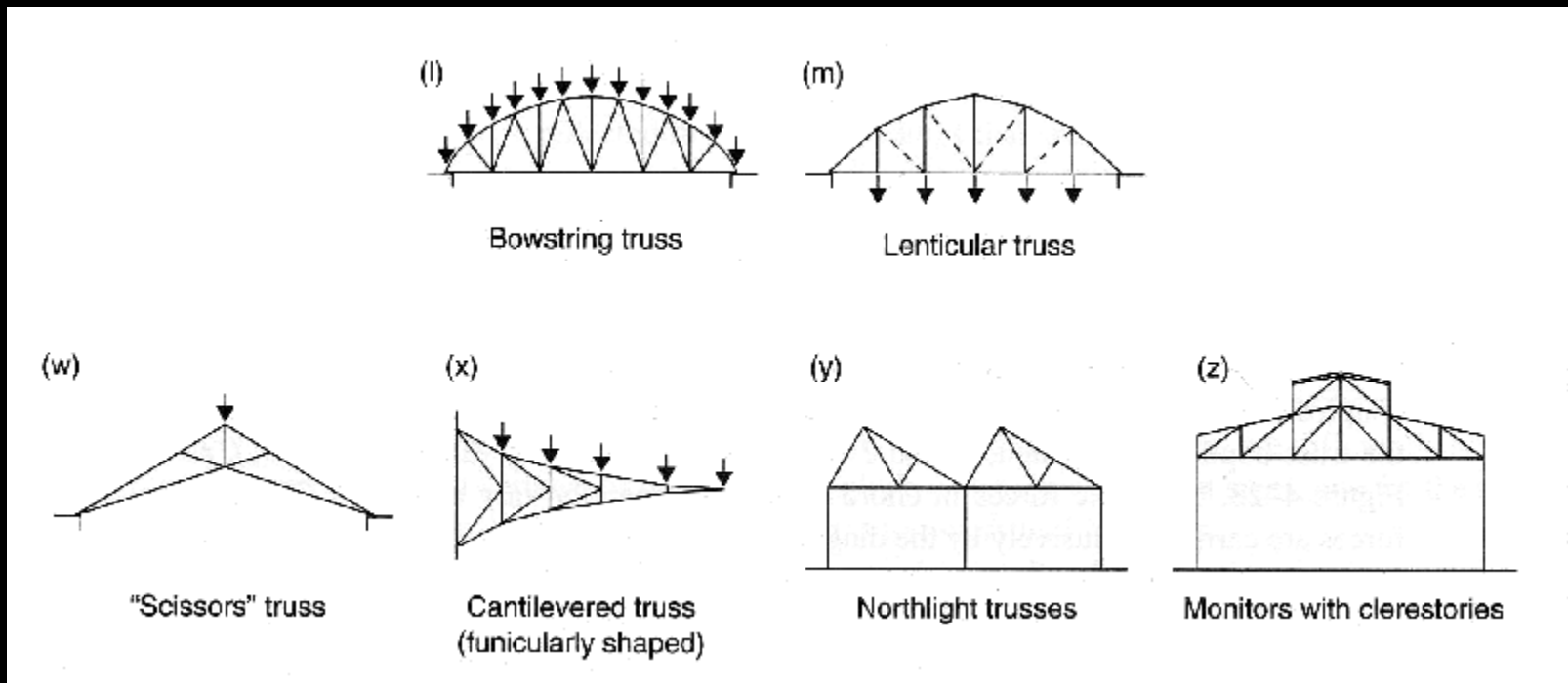

Trusses

- *uses*
 - *roofs & canopies*
 - *long spans*
 - *lateral bracing*

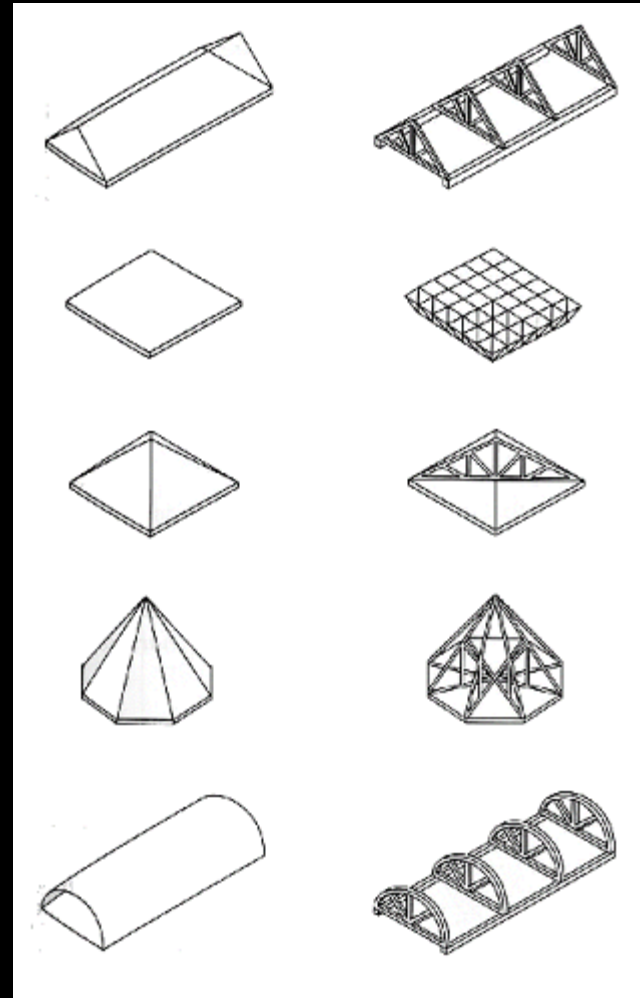
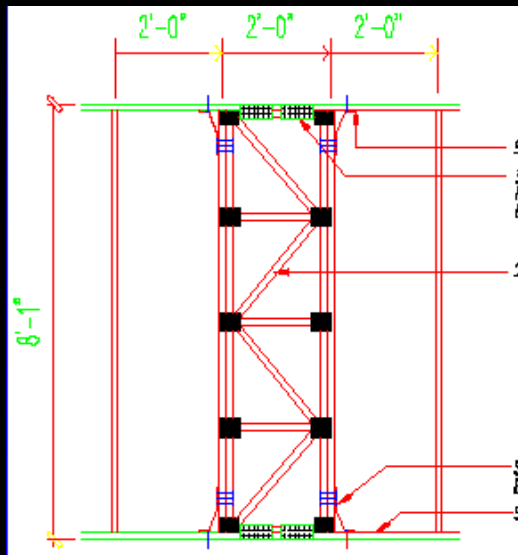

Truss Connections

- “pins”

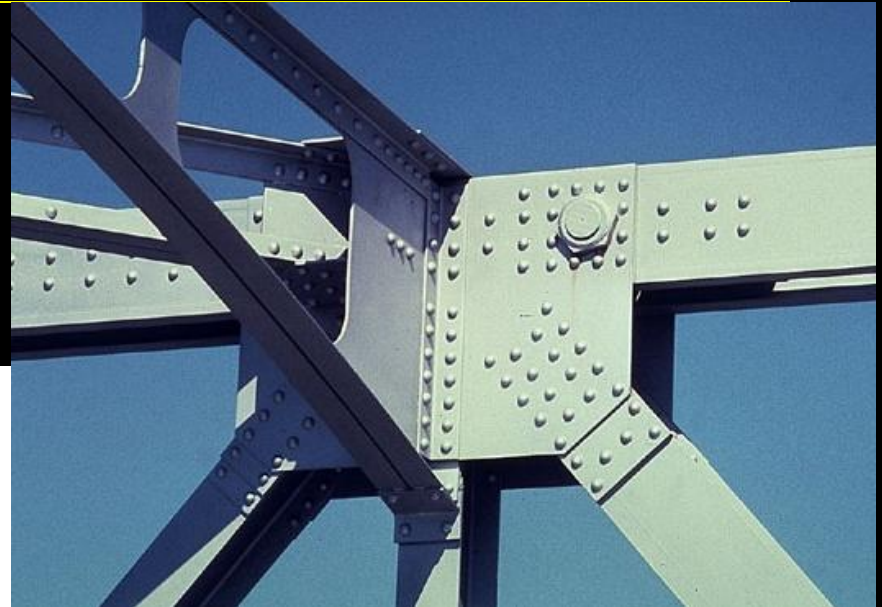

<http://nisee.berkeley.edu/godden>

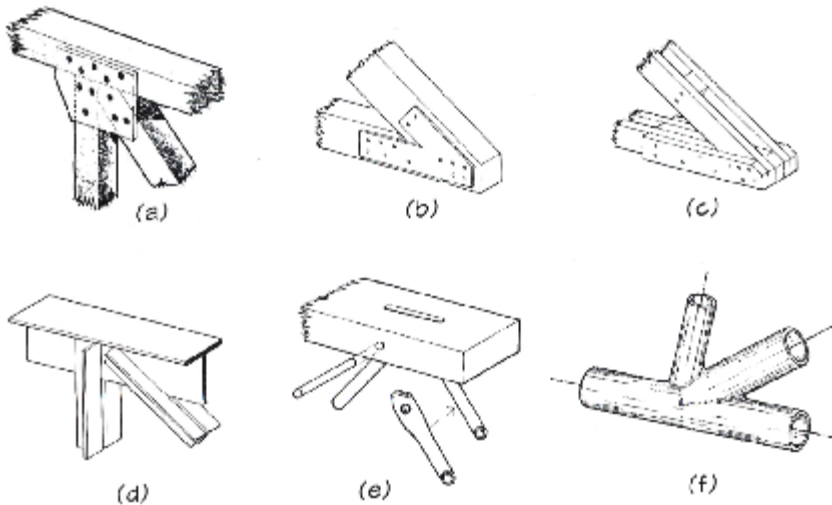
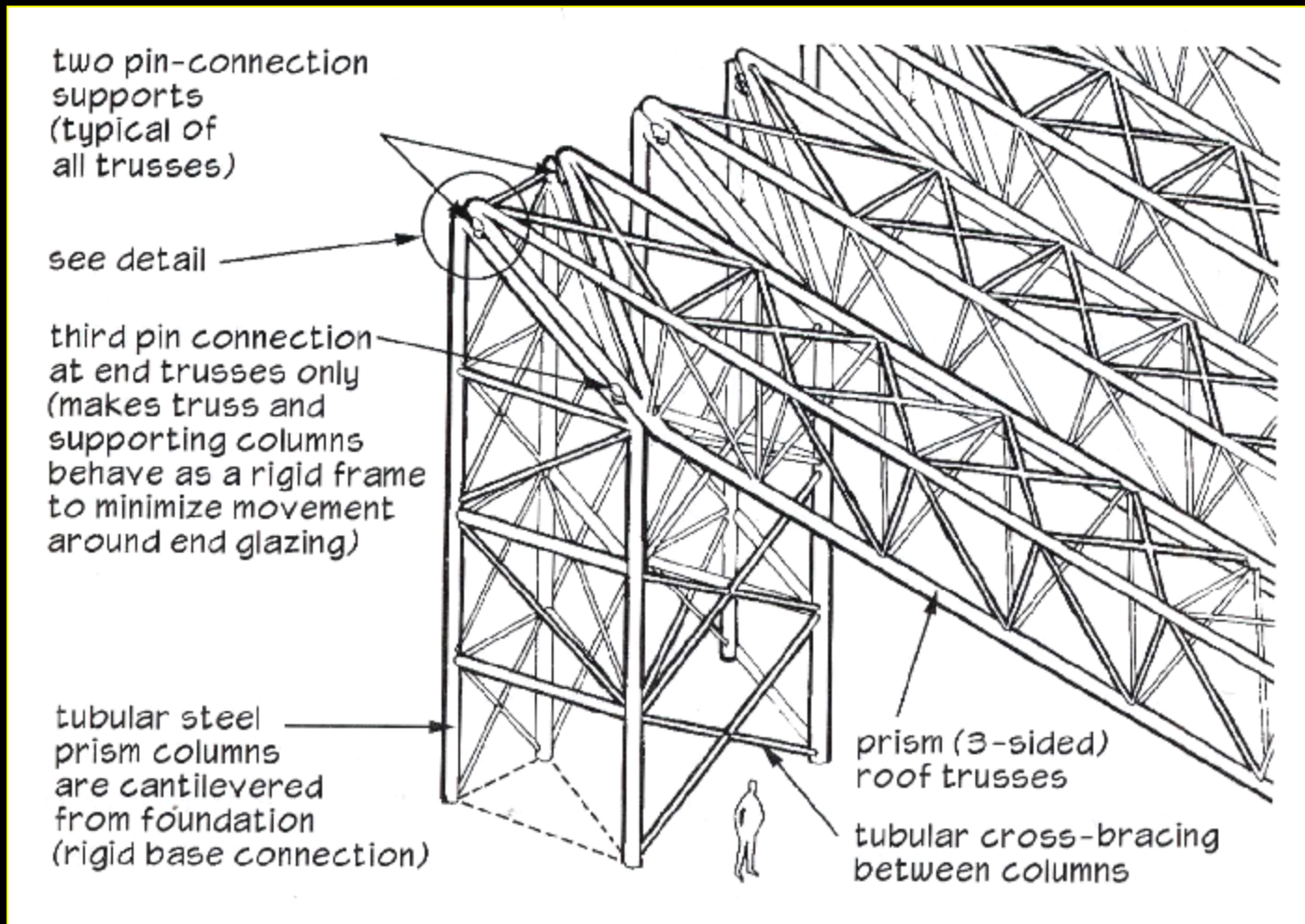

Figure 4.8: Truss joints.

Sainsbury Center, Foster 1978



Sainsbury Center, Foster 1978



Truss Analysis

- *visualize compression and tension from deformed shape*

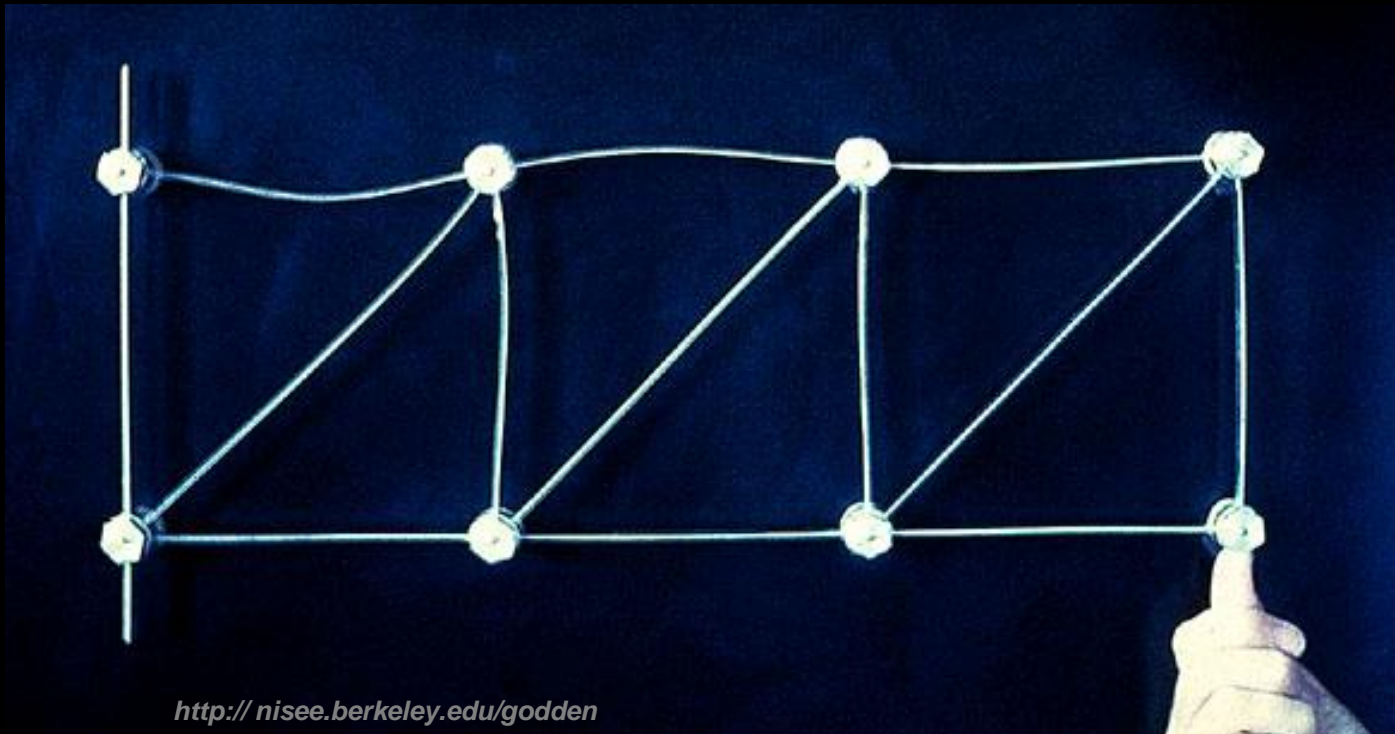

Truss Analysis

- Method of Joints
- Graphical Methods
- Method of Sections

- *all rely on equilibrium*
 - of bodies
 - internal equilibrium

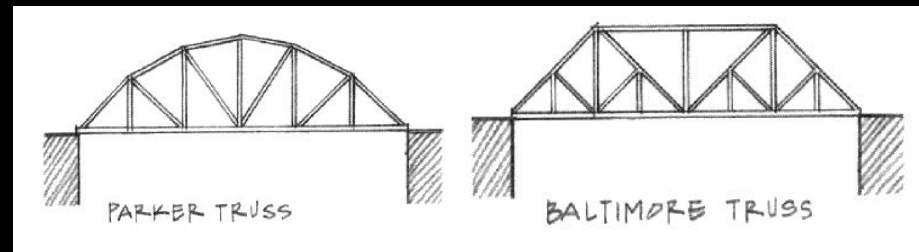
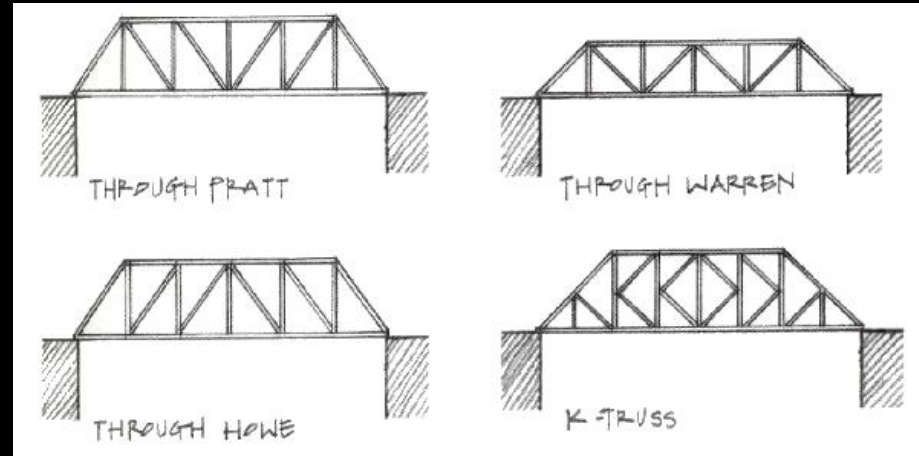

Method of Joints

- *isolate each joint*
- *enforce equilibrium in F_x and F_y*
- *can find all forces*
- *long*
- *easy to mess up*

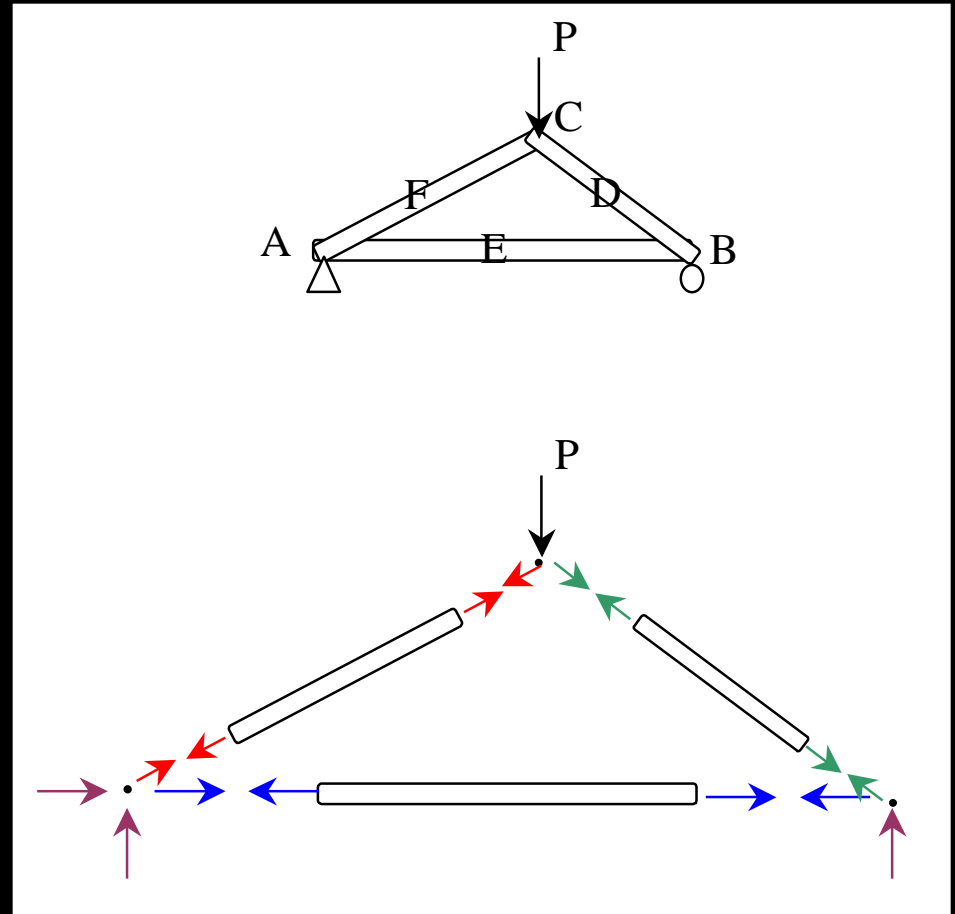

Joint Cases

- *two bodies connected*

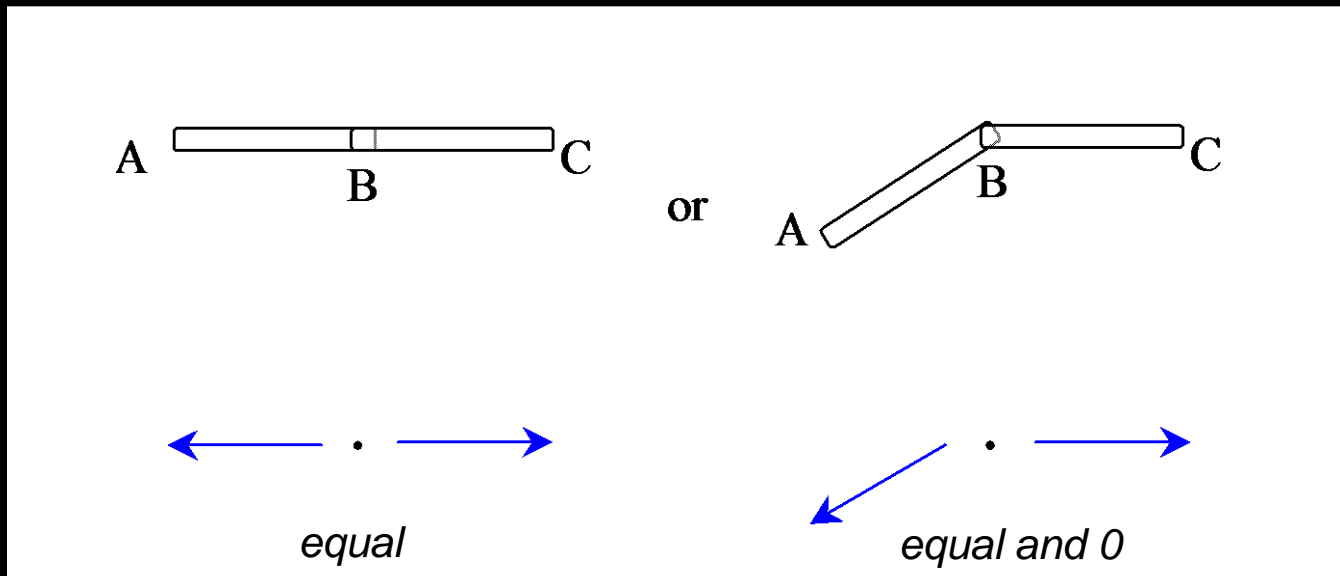

Joint Cases

- *three bodies with two in line*

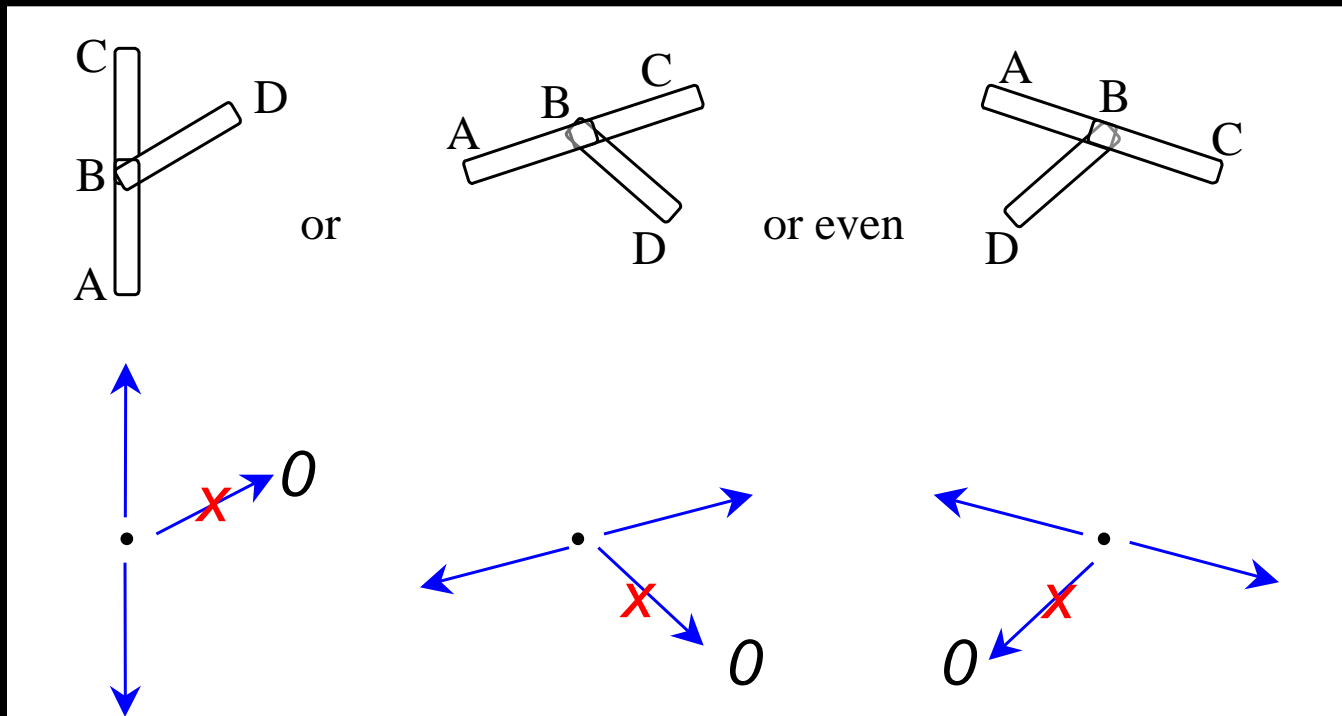

Joint Cases

- *crossed*

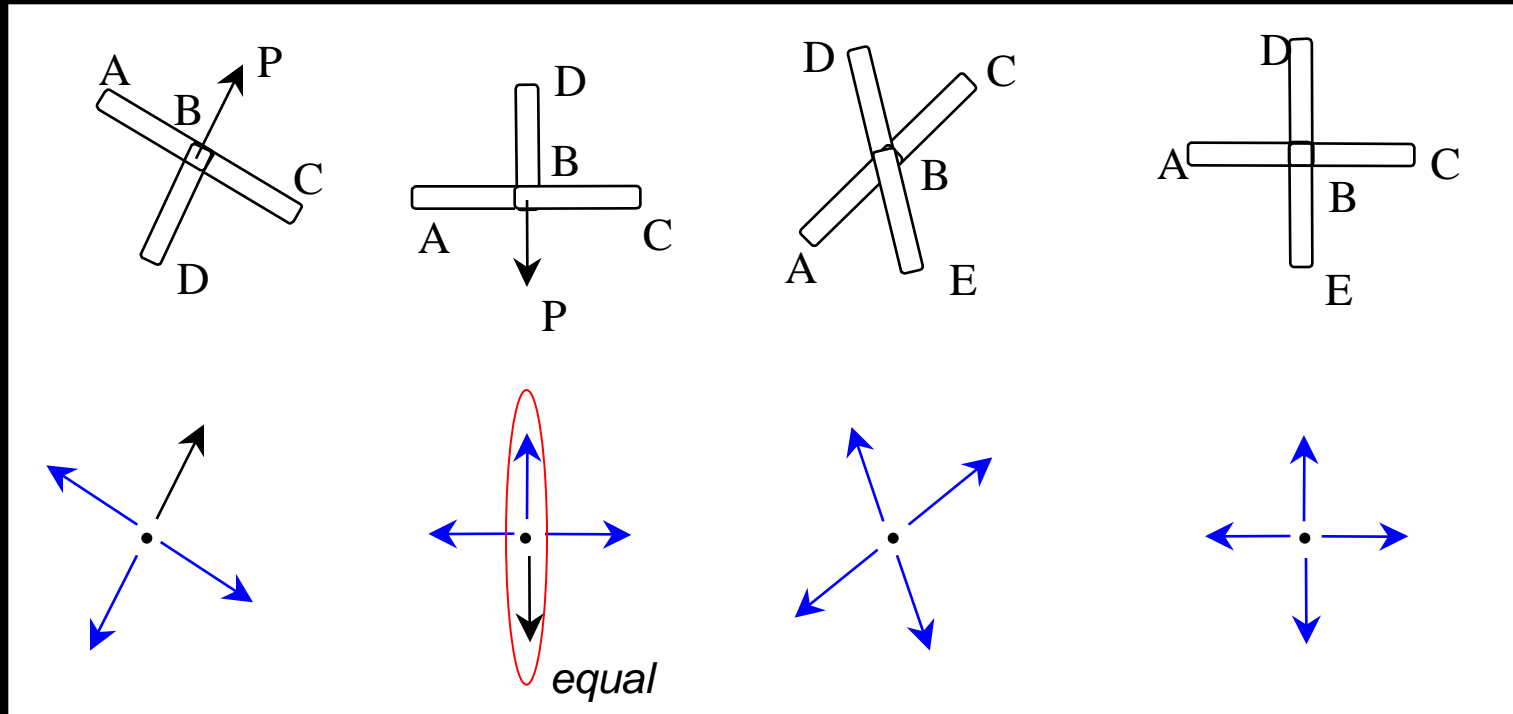

Tools – Multiframe

- *in computer lab*

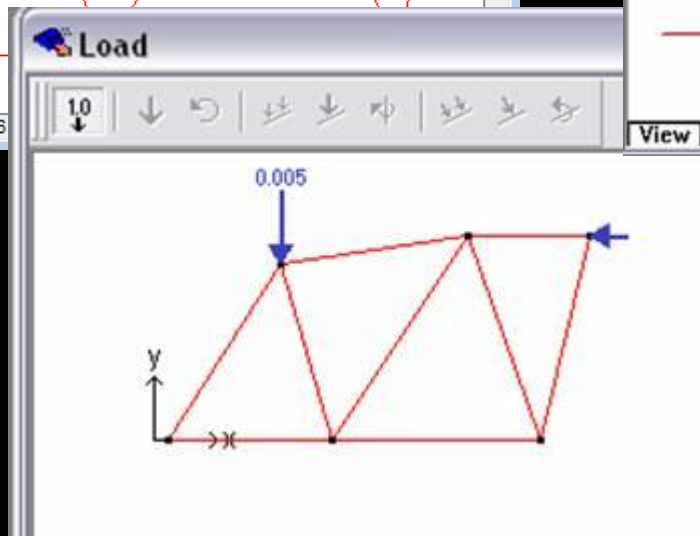
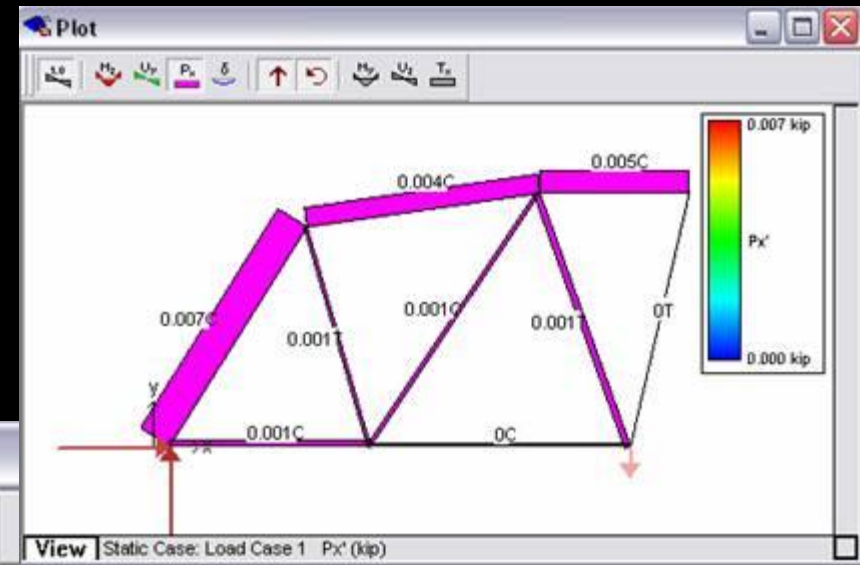
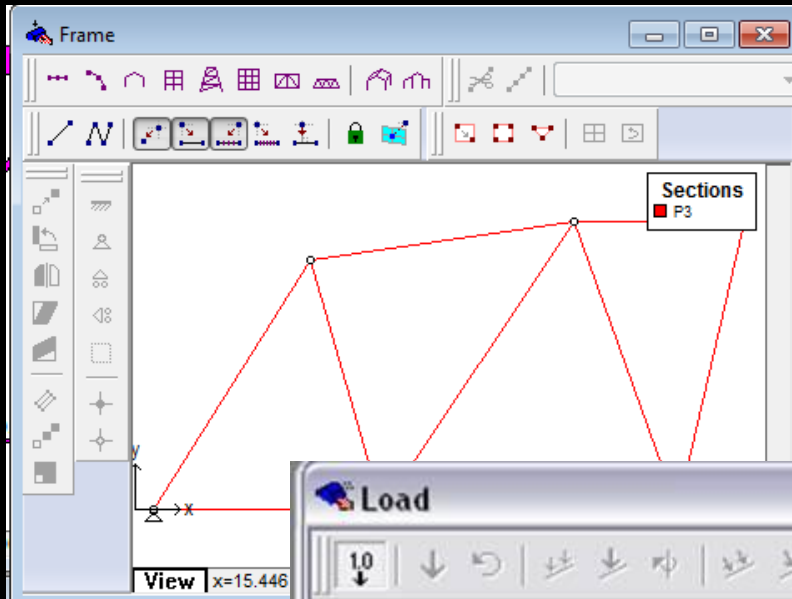

Tools – Multiframe

- *frame window*
 - *define truss members*
 - *or pre-defined truss*
 - *select points, assign supports*
 - *select members, assign section & assign pin ends*
- *load window*
 - *select points, add point load*

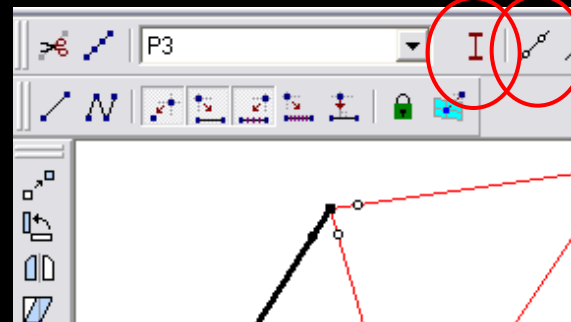
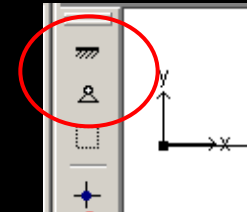
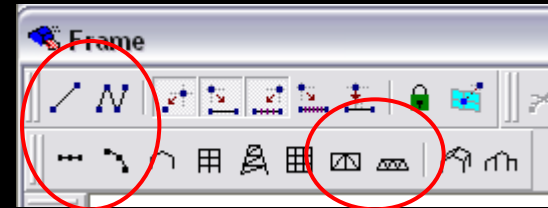

Tools – Multiframe

- *to run analysis choose*
 - *Analyze menu*
 - *Linear*
- *plot*
 - *choose options*
- *results*
 - *choose options*

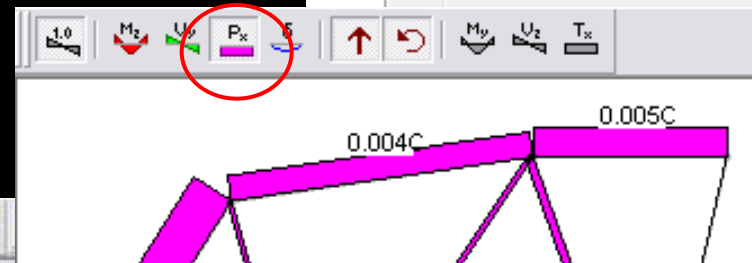
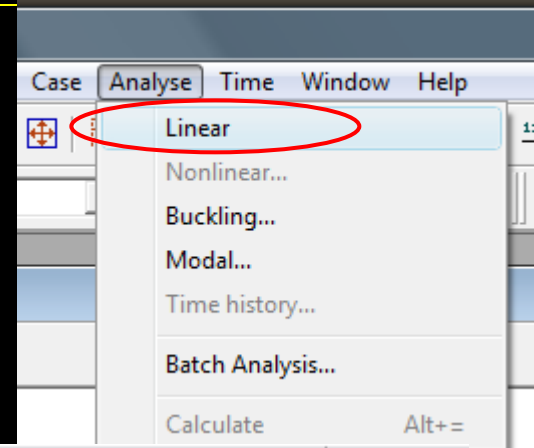

	Memb	Label	Joint	Px' kip
1	1		1	0.007
2	1		2	-0.007
3	2		2	-0.001
4	2		3	0.001
5	3		1	0.001
6	3		3	-0.001
7	4		2	0.004
8	4		4	-0.004