

**ARCHITECTURAL STRUCTURES:
FORM, BEHAVIOR, AND DESIGN**

ARCH 331

DR. ANNE NICHOLS

FALL 2013

lecture
twenty

**steel construction:
columns & tension members**

*Cor-Ten Steel Sculpture By Richard Serra
Museum of Modern Art Fort Worth, TX
(AISC - Steel Structures of the Everyday)*



Structural Steel

- *standard rolled shapes*
(W, C, L, T)
- *tubing*
- *pipe*
- *built-up*



Design Methods (revisited)

- *know*
 - *loads or lengths*
- *select*
 - *section or load*
 - *adequate for strength and no buckling*

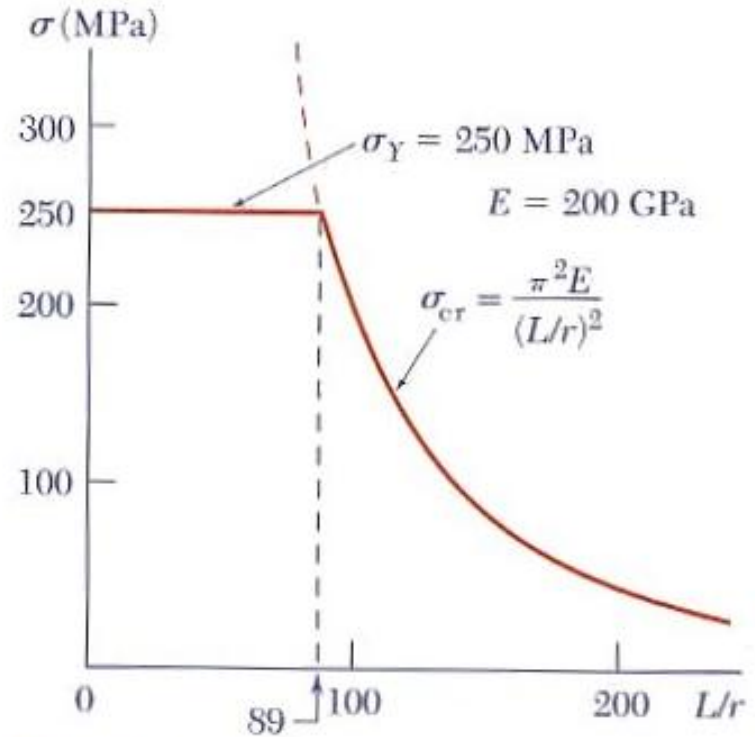

Fig. 10.9

Allowable Stress Design (ASD)

- AISC 9th ed

$$F_a = \frac{f_{critical}}{F.S.} = \frac{12\pi^2 E}{23 \left(\frac{Kl}{r} \right)^2}$$

- slenderness ratio $\frac{Kl}{r}$

– for $kl/r \geq C_c$ = 126.1 with $F_y = 36$ ksi
 = 107.0 with $F_y = 50$ ksi

C_c and Euler's Formula

- $Kl/r < C_c$
 - short and stubby
 - parabolic transition
- $Kl/r > C_c$
 - Euler's relationship
 - < 200 preferred

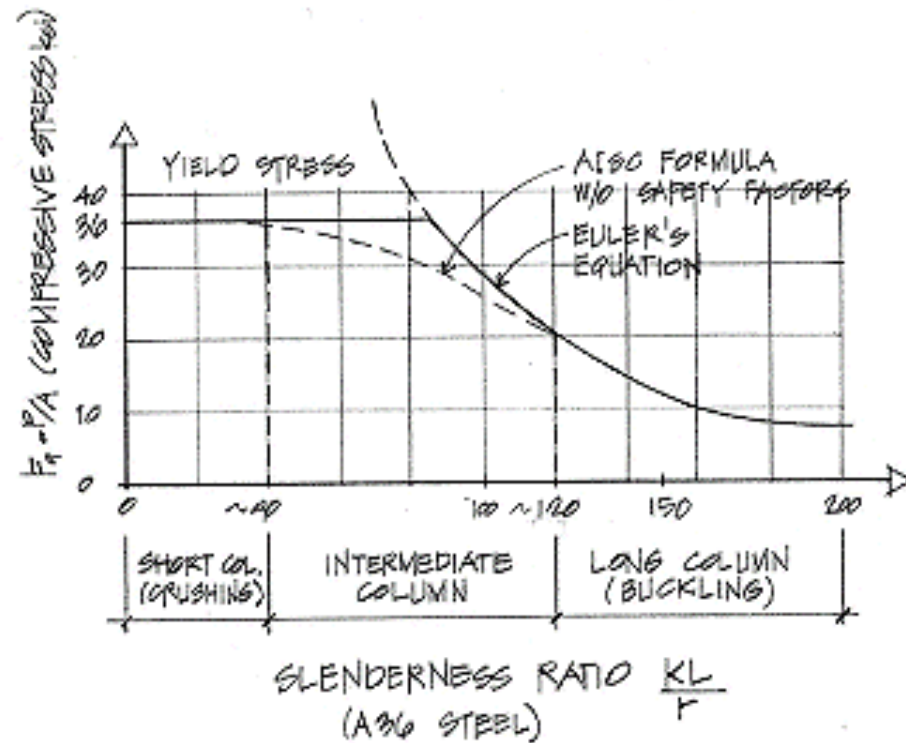

$$C_c = \sqrt{\frac{2\pi^2 E}{F_y}}$$

C_c and Euler's Formula

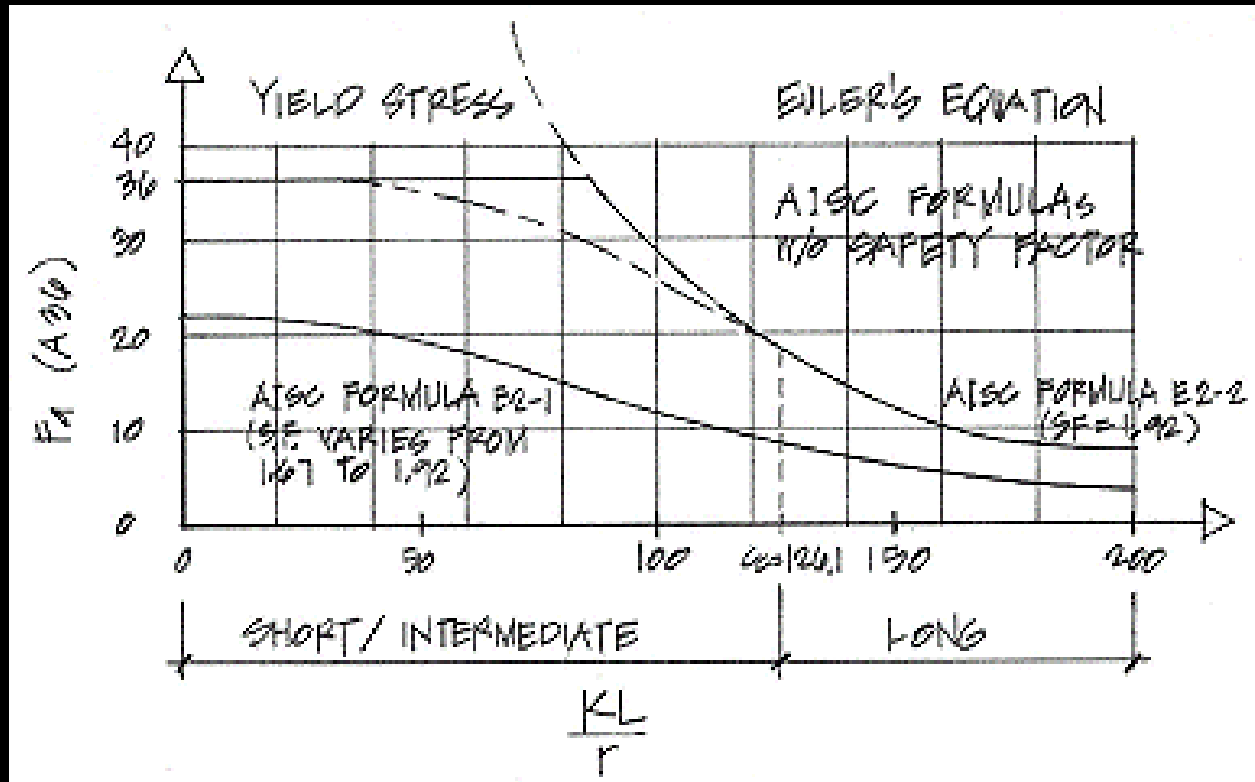

Short / Intermediate

- $L_e/r < C_c$

$$F_a = \left[1 - \frac{\left(Kl/r \right)^2}{2C_c^2} \right] \frac{F_y}{F.S.}$$

– where

$$F.S. = \frac{5}{3} + \frac{3\left(Kl/r \right)}{8C_c} - \frac{\left(Kl/r \right)^3}{8C_c^3}$$

Unified Design

- *limit states for failure* $P_a \leq P_n / \Omega$
 $\phi_c = 0.90$ $P_n = F_{cr} A_g$ $P_u \leq \phi_c P_n$

1. *yielding* $\frac{KL}{r} \leq 4.71 \sqrt{\frac{E}{F_y}}$ or $F_e \geq 0.44 F_y$

2. *buckling* $\frac{KL}{r} > 4.71 \sqrt{\frac{E}{F_y}}$ or $F_e < 0.44 F_y$
 F_e – elastic buckling stress (Euler)

Unified Design

- $P_n = F_{cr} A_g$

- for $\frac{KL}{r} \leq 4.71 \sqrt{\frac{E}{F_y}}$ $F_{cr} = \left[0.658 \frac{F_y}{F_e} \right] F_y$

- for $\frac{KL}{r} > 4.71 \sqrt{\frac{E}{F_y}}$ $F_{cr} = 0.877 F_e$

- where

$$F_e = \frac{\pi^2 E}{\left(\frac{KL}{r}\right)^2}$$

Procedure for Analysis

1. calculate KL/r
 - biggest of KL/r with respect to x axes and y axis
2. find F_a or F_{cr} from appropriate equation
 - tables are available
3. compute $P_{allowable} = F_a \cdot A$ or $P_n = F_{cr} A_g$
 - or find $f_{actual} = P/A$
4. is $P \leq P_{allowable}$ ($P_a \leq P_n/\Omega$)? or is $P_u \leq \phi P_n$?
 - yes: ok
 - no: insufficient capacity and no good

Procedure for Design

1. guess a size (pick a section)
2. calculate KL/r
 - biggest of KL/r with respect to x axes and y axis
3. find F_a or F_{cr} from appropriate equations
 - or find a chart
4. compute $P_{allowable} = F_a A$ ($P_n/\Omega = F_{cr} A_g$)
or $P_n = F_{cr} A_g$
 - or find $f_{actual} = P/A$

Procedure for Design (cont'd)

5. is $P \leq P_{allowable}$ ($P_a \leq P_n/\Omega$)? or is $P_u \leq \phi P_n$?

- yes: ok
- no: pick a bigger section and **go back to step 2.**

6. check design efficiency

- percentage of stress = $\frac{P_r}{P_c} \cdot 100\%$
- if between 90-100%: good
- if < 90%: pick a smaller section and **go back to step 2.**

Column Charts, F_a (pg. 361-364)

Table 10.1 Allowable stress for compression members ($F_y = 36$ ksi and $F_y = 250$ MPa).

$\frac{KL}{r}$	F_a (ksi)	F_a (MPa)	$\frac{KL}{r}$	F_a (ksi)	F_a (MPa)	$\frac{KL}{r}$	F_a (ksi)	F_a (MPa)
1	21.56	148.7	41	19.11	131.8	81	15.24	105.1
2	21.52	148.4	42	19.03	131.2	82	15.13	104.3
3	21.48	148.1	43	18.95	130.7	83	15.02	103.6
4	21.44	147.8	44	18.86	130.0	84	14.90	102.7
5	21.39	147.5	45	18.78	129.5	85	14.79	102.0
6	21.35	147.2	46	18.70	128.9	86	14.67	101.1
7	21.30	146.9	47	18.61	128.3	87	14.56	100.4
8	21.25	146.5	48	18.53	127.8	88	14.44	99.6
9	21.21	146.2	49	18.44	127.1	89	14.32	98.7
10	21.16	145.9	50	18.35	126.5	90	14.20	97.9
11	21.10	145.5	51	18.26	125.9	91	14.09	97.2
12	21.05	145.1	52	18.17	125.3	92	13.97	96.3
13	21.00	144.8	53	18.08	124.7	93	13.84	95.4
14	20.95	144.5	54	17.99	124.0	94	13.72	94.6
15	20.89	144.0	55	17.90	123.4	95	13.60	93.8
16	20.83	143.6	56	17.81	122.8	96	13.48	92.9
17	20.78	143.3	57	17.71	122.1	97	13.35	92.0
18	20.72	142.9	58	17.62	121.5	98	13.23	91.2

Column Charts, ϕF_{cr}

Available Critical Stress, $\phi_c F_{cr}$, for Compression Members, ksi ($F_y = 50$ ksi and $\phi_c = 0.90$)

KL/r	$\phi_c F_{cr}$	KL/r	$\phi_c F_{cr}$	KL/r	$\phi_c F_{cr}$	KL/r	$\phi_c F_{cr}$	KL/r	$\phi_c F_{cr}$
1	45.0	41	39.8	81	27.9	121	15.4	161	8.72
2	45.0	42	39.6	82	27.5	122	15.2	162	8.61
3	45.0	43	39.3	83	27.2	123	14.9	163	8.50
4	44.9	44	39.1	84	26.9	124	14.7	164	8.40
5	44.9	45	38.8	85	26.5	125	14.5	165	8.30
6	44.9	46	38.5	86	26.2	126	14.2	166	8.20
7	44.8	47	38.3	87	25.9	127	14.0	167	8.10
8	44.8	48	38.0	88	25.5	128	13.8	168	8.00
9	44.7	49	37.8	89	25.2	129	13.6	169	7.91
10	44.7	50	37.5	90	24.9	130	13.4	170	7.82
11	44.6	51	37.2	91	24.6	131	13.2	171	7.73
12	44.5	52	36.9	92	24.2	132	13.0	172	7.64
13	44.4	53	36.6	93	23.9	133	12.8	173	7.55
14	44.4	54	36.4	94	23.6	134	12.6	174	7.46
15	44.3	55	36.1	95	23.3	135	12.4	175	7.38
16	44.2	56	35.8	96	22.9	136	12.2	176	7.29
17	44.1	57	35.5	97	22.6	137	12.0	177	7.21
18	43.9	58	35.2	98	22.3	138	11.9	178	7.13
19	43.8	59	34.9	99	22.0	139	11.7	179	7.05
20	43.7	60	34.6	100	21.7	140	11.5	180	6.97
21	43.6	61	34.3	101	21.3	141	11.4	181	6.90
22	43.4	62	34.0	102	21.0	142	11.2	182	6.82
23	43.3	63	33.7	103	20.7	143	11.0	183	6.75
24	43.1	64	33.4	104	20.4	144	10.9	184	6.67
25	43.0	65	33.0	105	20.1	145	10.7	185	6.60

Column Charts

$F_y = 50$ ksi

Table 4-1 (continued) Available Strength in Axial Compression, kips W Shapes



Shape		W12x									
Wt/ft		96		87		79		72		65	
Design		P_n/Ω_c	$\phi_c P_n$	P_n/Ω_c	$\phi_c P_n$	P_n/Ω_c	$\phi_c P_n$	P_n/Ω_c	$\phi_c P_n$	P_n/Ω_c	$\phi_c P_n$
		ASD	LRFD	ASD	LRFD	ASD	LRFD	ASD	LRFD	ASD	LRFD
radius of gyration r_y	0	844	1270	766	1150	694	1040	633	951	571	859
	6	811	1220	735	1110	667	1000	607	913	548	824
	7	800	1200	725	1090	657	987	598	899	540	811
	8	787	1180	713	1070	646	971	588	884	531	798
	9	772	1160	699	1050	634	952	577	867	520	782
	10	756	1140	685	1030	620	932	565	849	509	765
	11	739	1110	669	1010	606	910	551	828	497	747

Beam-Column Design

- *moment magnification ($P-\Delta$)*

$$M_u = B_1 M_{max-factored} \quad B_1 = \frac{C_m}{1 - (P_u / P_{e1})}$$

C_m – *modification factor for end conditions*

$$= 0.6 - 0.4(M_1/M_2) \text{ or}$$

0.85 restrained, 1.00 unrestrained

P_{e1} – *Euler buckling strength* $P_{e1} = \frac{\pi^2 EA}{\left(\frac{Kl}{r}\right)^2}$

Beam-Column Design

- *LRFD (Unified) Steel*

– for $\frac{P_r}{P_c} \geq 0.2$:
$$\frac{P_u}{\phi_c P_n} + \frac{8}{9} \left(\frac{M_{ux}}{\phi_b M_{nx}} + \frac{M_{uy}}{\phi_b M_{ny}} \right) \leq 1.0$$

– for $\frac{P_r}{P_c} < 0.2$:
$$\frac{P_u}{2\phi_c P_n} + \left(\frac{M_{ux}}{\phi_b M_{nx}} + \frac{M_{uy}}{\phi_b M_{ny}} \right) \leq 1.0$$

P_r is required, P_c is capacity

ϕ_c - resistance factor for compression = 0.9

ϕ_b - resistance factor for bending = 0.9

Design Steps Knowing Loads *(revisited)*

1. *assume limiting stress*
 - *buckling, axial stress, combined stress*
2. *solve for r , A or S*
3. *pick trial section*
4. *analyze stresses*
5. *section ok?*
6. *stop when section is ok*

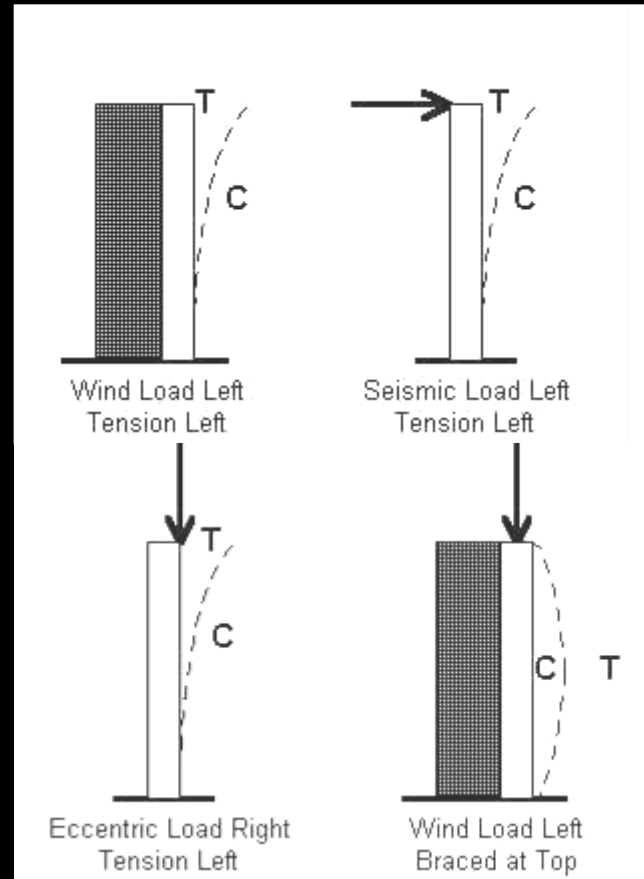

Rigid Frame Design (revisited)

- columns in frames
 - ends can be “flexible”
 - stiffness affected by beams and column = EI/L

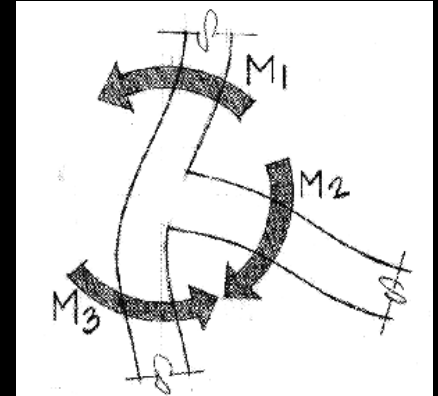

$$G = \Psi = \frac{\sum EI / l_c}{\sum EI / l_b}$$

- for the joint

- l_c is the column length of each column
- l_b is the beam length of each beam
- measured center to center

Rigid Frame Design (revisited)

- column effective length, k

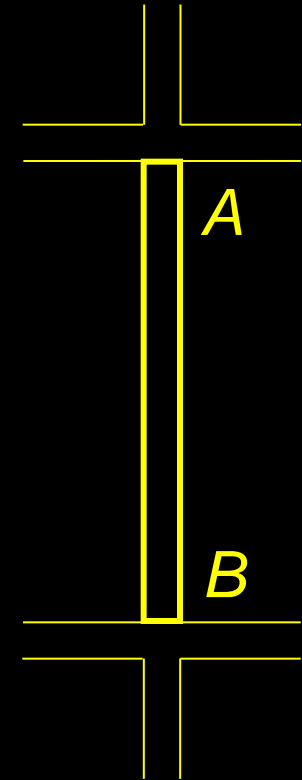
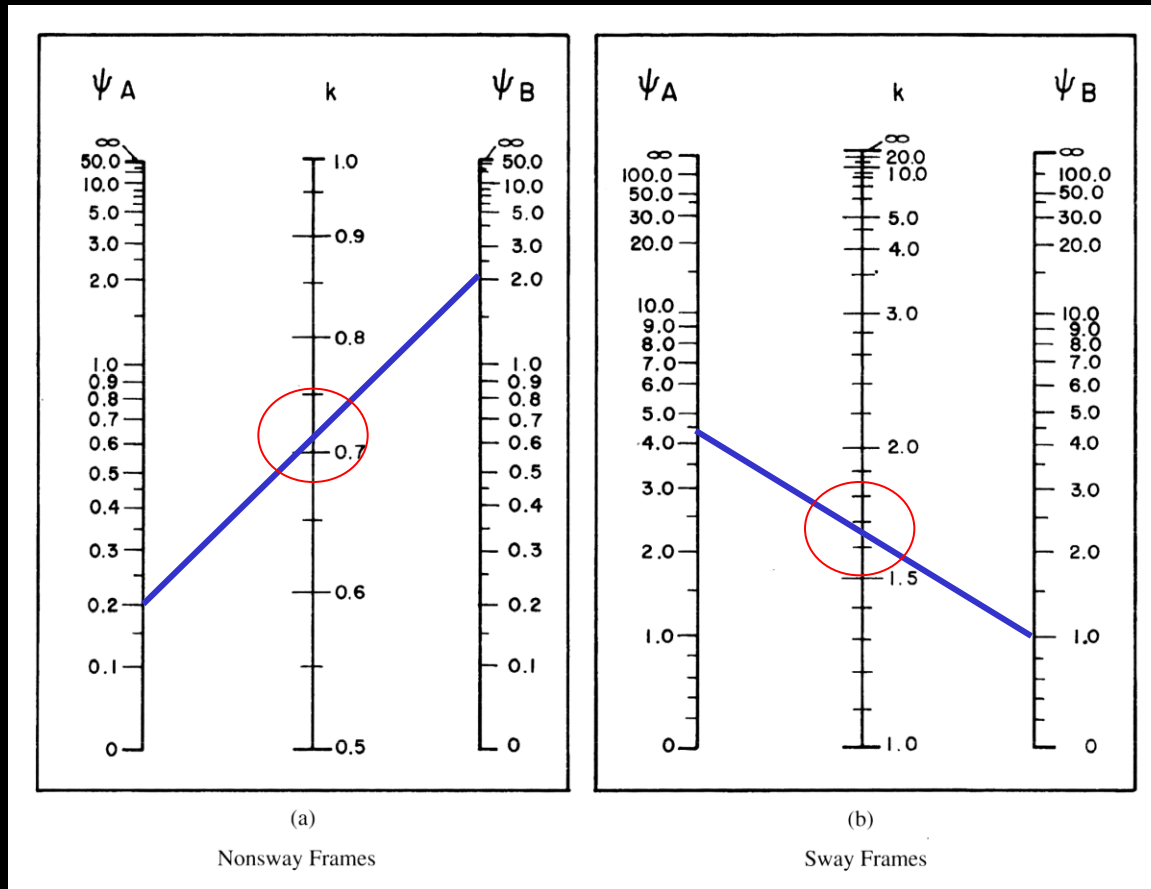

Tension Members

- steel members can have holes
- reduced area

$$A_n = A_g - A_{\text{of all holes}} + t \sum \frac{s^2}{4g}$$

- increased stress



(AISC - Steel Structures of the Everyday)

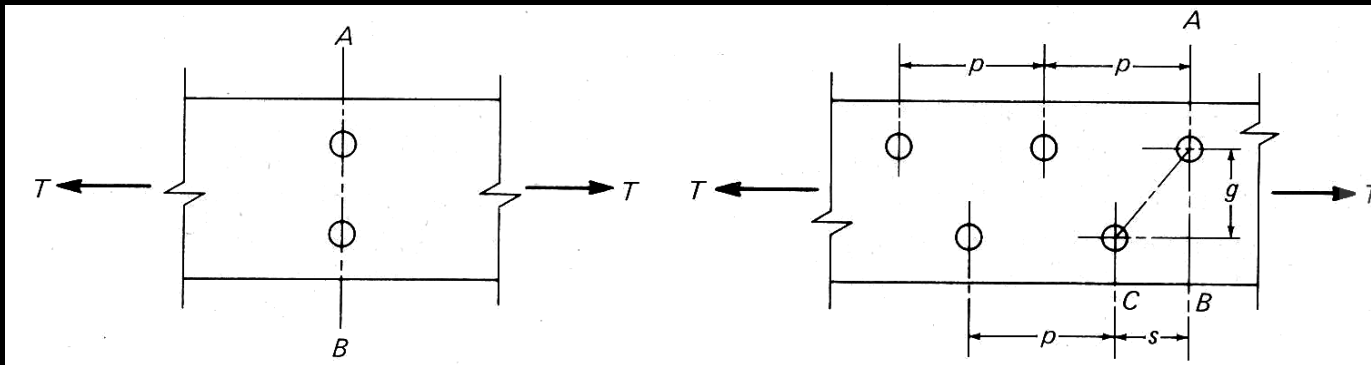

Effective Net Area

- likely path to “rip” across
- bolts divide transferred force too
- shear lag $A_e \leq A_n U$

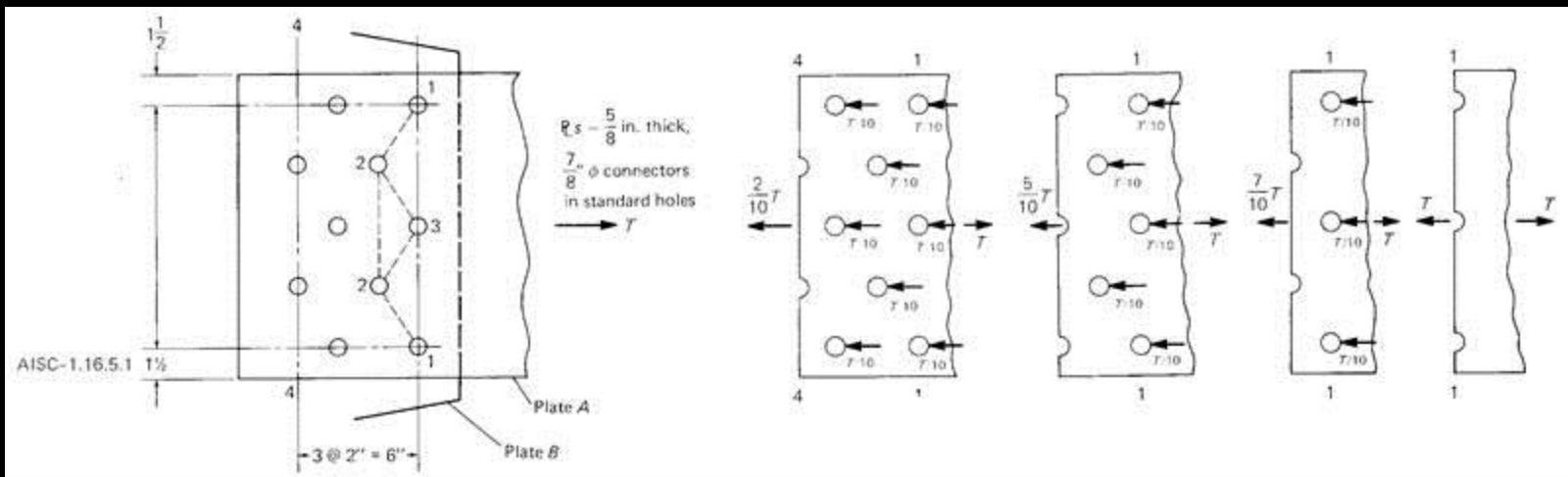

Tension Members

- limit states for failure

$$P_a \leq \frac{P_n}{\Omega} \quad P_u \leq \phi_t P_n$$

1. yielding $\phi_t = 0.90$ $P_n = F_y A_g$

2. rupture* $\phi_t = 0.75$ $P_n = F_u A_e$

A_g - gross area

A_e - effective net area
(holes $1/8'' + d$)

F_u = the tensile strength of the steel (ultimate)

