



# Technical Notes on Brick Construction

17B  
REVISED

March  
1999

Brick Industry Association 11490 Commerce Park Drive, Reston, Virginia 20191

## REINFORCED BRICK MASONRY BEAMS

**Abstract:** Reinforced brick masonry (RBM) beams are an efficient and attractive means of spanning building openings. The addition of steel reinforcement and grout permits brick masonry to span considerable distances while maintaining continuity of the building facade. Attractive brick soffits and elimination of steel support members are two of the advantages of reinforced brick masonry beams. This *Technical Notes* addresses the design of reinforced brick masonry beams. Building code requirements are reviewed and design aids are provided to simplify the design process. Illustrations indicate the proper detailing and typical construction of reinforced brick masonry beams.

**Key Words:** beam, deflection, girder, lintel, reinforced brick masonry, reinforcement.

### INTRODUCTION

Reinforced brick masonry (RBM) beams are widely used as flexural members. Common applications of RBM beams include girders supporting floor and roof systems, and arches and lintels spanning openings for windows and doors. Girder is the term applied to a large beam with a long span that usually supports smaller framing members. A lintel is a beam over a wall opening, typically simply supported with no framing members. The main advantage of RBM beams is that the structural element and the architectural finish are one and the same. In some cases, however, they provide economical solutions without considering the savings due to a built-in finish. They are often built as an integral part of a masonry wall as illustrated in Figure 1. RBM beams are designed to carry all superimposed loads, including that portion of the wall weight above

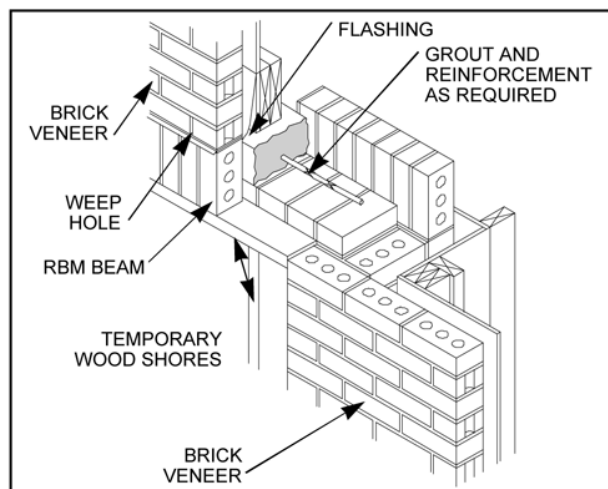

Typical RBM Beam in Brick Veneer Wall  
FIG. 1

supported by the beam. While steel lintels are more common, RBM beams provide distinct advantages over steel lintels. Among the advantages are:

1. More efficient use of materials. The masonry serves as a structural element with a relatively small amount of steel reinforcement added.
2. Elimination of differential movement. This movement is often the cause of cracks in masonry.
3. Inherent fire resistance.
4. Reduced maintenance. Periodic painting of exposed steel is eliminated.
5. Lower cost.

This *Technical Notes* provides a review of the design of RBM beams. Factors influencing design and performance are reviewed. Design recommendations and aids are provided and their use illustrated with an example. For additional information about RBM beams and design calculations, refer to the *Masonry Designers' Guide* (MDG) [2]. The MDG also provides an extensive review of the requirements of the *Building Code Requirements for Masonry Structures* (ACI 530/ASCE 5/TMS 402-95)[1], hereafter termed the MSJC Code. Other *Technical Notes* in this series provide the history of RBM, material and construction requirements, and design of other RBM elements.

This *Technical Notes* does not address the design of deep beams (wall beams) or bond beams. A deep beam is one with a depth-to-span ratio exceeding 0.8. Assumptions made in this *Technical Notes* regarding the distribution of stress in beams under flexure and the loading conditions do not apply to deep beams. Bond beams are formed by placing horizontal reinforcement in a wall without an opening underneath.

### NOTATION

Following are notations used in the text, figures, and table in this *Technical Notes*.

- $A_v$  Area of shear reinforcement, in.<sup>2</sup> (mm<sup>2</sup>)  
 $b$  Length of bearing plate, ft (m)  
 $d$  Effective depth of beam, in. (mm)  
 $d_b$  Nominal diameter of reinforcement, in. (mm)  
 $F_s$  Allowable steel stress, psi (MPa)  
 $f'_m$  Specified compressive strength of masonry, psi (MPa)  
 $H$  Height of beam, in. (mm)  
 $l_d$  Embedment length of reinforcement, in. (mm)  
 $M_G$  Design moment due to gravity loads, in.-lb (N-m)  
 $M_s$  Design moment due to in-plane shear, in.-lb (N-m)  
 $M_w$  Design moment due to out-of-plane wind or seismic load, in.-lb (N-m)  
 $P$  Design concentrated load, lb (kg)  
 $s$  Spacing of shear reinforcement, in. (mm)  
 $V$  Design shear force, lb (kg)  
 $W$  Width of beam, in. (mm)  
 $w_p$  Design uniform distributed load, lb/ft (kg/m)  
 $y$  Distance from top of beam to bearing plate, ft (m)

### DETERMINATION OF LOADING

The basic concept of a beam is as a pure flexural member. A flexural member spans an opening and transfers vertical gravity loads to its supports, as illustrated in Fig. 2(a). RBM beams act in this manner to support their own weight and other applied gravity loads. However, it is also common for RBM beams to be part of a masonry wall. As such, RBM beams are often subjected to out-of-plane wind and seismic forces, as depicted in Fig. 2(b). This causes bending of the RBM beam in the out-of-plane direction, which is often about the weak axis of the beam. In addition, reinforced masonry walls may be shear-resisting members, or “shear walls”, which are part of the lateral load-resisting system of a building. In such a structural system, RBM beams may be used as connections between shear walls or piers, as illustrated in Fig. 2(c). Such beams are called coupling beams because they “couple” the shear walls or piers. If the relative sizes of the two piers being coupled are similar, the RBM beam is subject to considerable load when an in-plane shear force is applied to the wall. This is why damage to masonry shear walls is often concentrated at coupling beams following an earthquake or high-wind event.

The designer should consider all aspects of loading for an RBM beam. It is difficult to predict the loading condition that will produce the critical design condition. For example, a RBM beam that is part of a wall will be subject to a combination of gravity loads and out-of-plane wind or seismic loads. Many factors influence the loading conditions for RBM beams.

### Arching Action

Arching action is a property of all masonry walls which are laid in an overlapping bond pattern. Brick masonry will span, in a step-like manner similar to a corbel, over a wall opening when laid in running bond pattern. Vertical gravity loads above the openings are

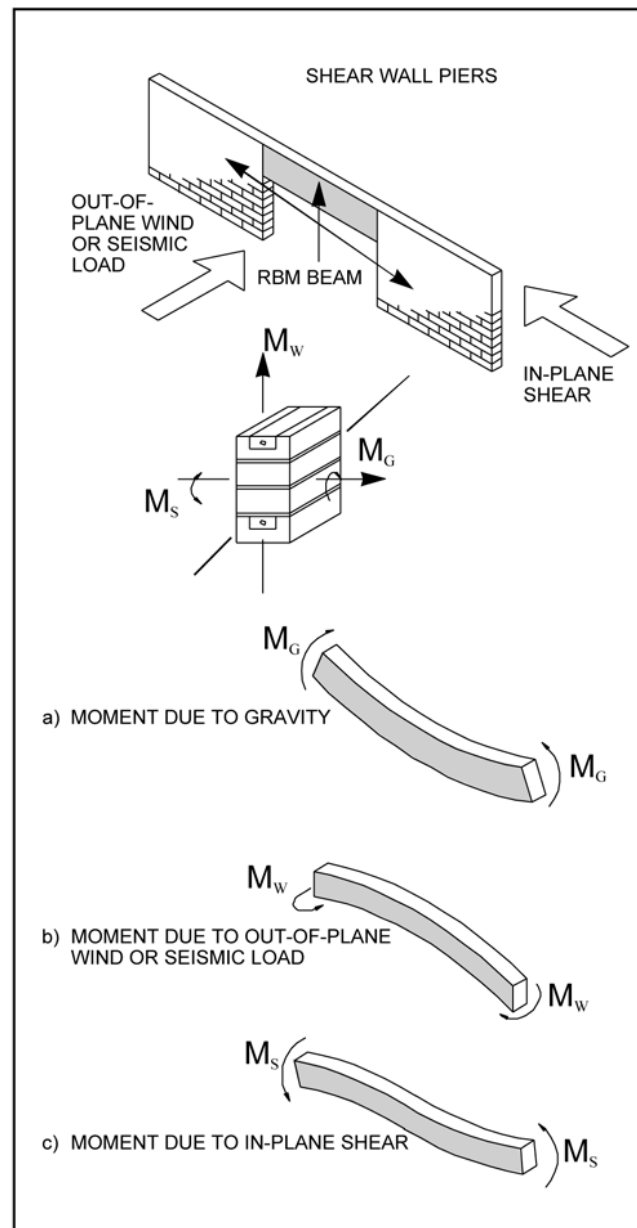

Moments on RBM Beam  
FIG. 2

transferred to the wall elements on each side. This is the reason why sizable holes can be created in masonry walls without causing collapse. Arching action will occur provided that the following conditions are met:

1. An overlapping bond pattern is used in the masonry surrounding the opening.
2. The masonry above the apex of a 45 degree isosceles triangle above the beam exceeds 12 in. (300 mm).
3. There are no movement joints or adjacent wall openings that hinder the load path of arching action.
4. The abutments are sufficiently strong and rigid to resist the horizontal thrust due to arching action.

These concepts are illustrated in Fig. 3.

Provided arching action occurs, the self weight of masonry wall carried by the beam may be safely as-

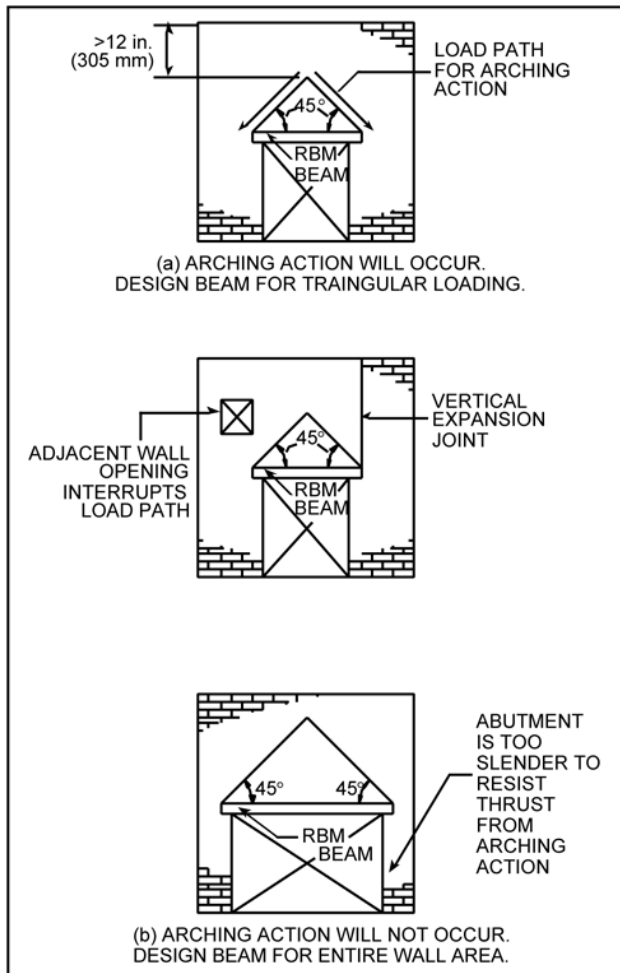

**Conditions for Arching Action**  
**FIG. 3**

summed as the weight within a triangular area above the beam formed by 45 degree angles, as shown in Fig. 3. The self weight of the wall must be added to the live and dead loads of floors and roofs which bear on the wall above the opening. If a stack bond pattern is used, the full area of brick masonry above the wall opening should be considered in the RBM beam design with no assumption of arching action.

**Concentrated Loads**

Loads from beams, girders, trusses and other concentrated loads that frame into the wall must be applied to the RBM beam in the appropriate manner. Concentrated loads may be assumed to be distributed over a wall length equal to the base of a trapezoid whose top is at the point of load application and whose sides make an angle of 60 degrees with the horizontal. In Fig. 4, the portion of the concentrated load carried by the beam is distributed over the length indicated as a uniform load. The distributed load,  $w_p$ , on the RBM beam is computed by the following equation:

$$w_p = P / (b + 2y \tan 30) \quad \text{Eq. 1}$$

where:

- $w_p$  = design uniform distributed load, lb/ft (kg/m)
- $P$  = design concentrated load, lb (kg)

$b$  = length of bearing plate, ft (m)

$y$  = distance from top of beam to bearing plate, ft (m)

This is approximately 0.866 times  $P$  divided by  $y$ . Because the apex of the 45 degree triangle is above the top of the wall in this example, the RBM beam should be designed assuming no arching action occurs.

The designer should check the stress condition at bearing points for RBM beams. This applies to loads on the beam and to the beam's reaction on the wall. The MSJC Code limits the bearing stress to  $0.25 f'_m$ , where  $f'_m$  is the specified compressive strength of masonry. A rule-of-thumb recommended for many years is to provide a minimum of 4 in. (100 mm) of bearing length for masonry beams. The masonry directly beneath a bearing point should be constructed with solid brick or with solidly grouted hollow brick. Concentrated loads should not bear directly on ungrouted hollow brick masonry because of the potential for localized cracking or crushing of the face shells.

**Construction Loads**

When designing a RBM beam that is prefabricated or built on the ground and lifted into place, it is important to consider the loads during transport and handling. To address these loads, the beam may require reinforcement at both the top and bottom of the beam. Beams built in place are constructed on shores. These must be designed for the dead weight of the beam plus any superimposed load prior to adequate curing of the reinforced brickwork.

**Movement Joints**

Movement joints are a necessity in masonry walls to accommodate differential movement and avoid cracking. It is common to place vertical expansion joints at or near the jamb of wall openings. In RBM buildings there is a reduced need for expansion joints and such joints may be spaced farther apart. Refer to *Technical Notes 18 Series* for a discussion of the placement of movement joints. The presence of a movement joint

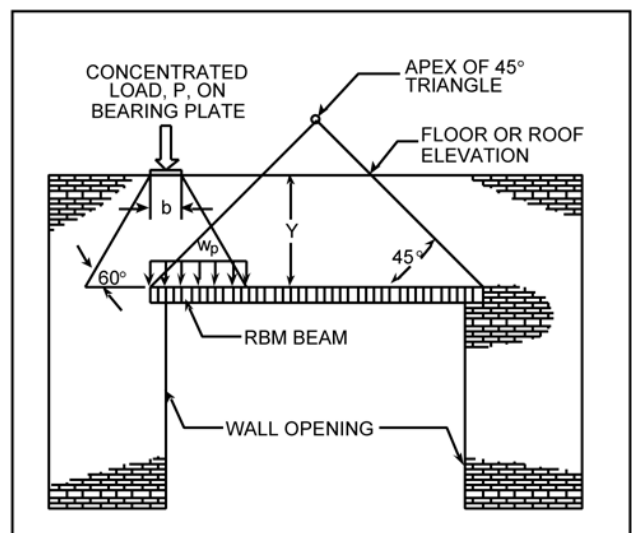

**Loads on RBM Beam**  
**FIG. 4**

near a RBM beam will influence the loads and support conditions for the beam. For example, a simple support condition should be assumed since arching action will not occur if a movement joint is at or near the jamb of the opening. Furthermore, the beam will not act as a coupling beam between shear walls. This is, in fact, one means of simplifying the design and function of a RBM beam by eliminating loads due to in-plane shear.

## DESIGN OF RBM BEAMS

RBM beam design should not be relegated to “rule-of-thumb” methods or arbitrary selection of beam configuration and steel reinforcement. In any beam design, a careful analysis of the loads to be carried and a calculation of the resultant stresses should be incorporated to provide adequate strength and to prevent excessive cracking and deflection.

In addition to adequate strength, it is preferred that beams exhibit ductile behavior when overloaded. If the beam is overloaded, it should deform (deflect) a considerable amount prior to collapse. Deformation allows redistribution of loads to other members and provides visual indication that the beam is overloaded. Some building codes stipulate a maximum reinforcement ratio for RBM beams for this purpose.

Another aspect is the relation between the RBM beam’s strength and its cracking moment. Failure of unreinforced masonry in flexure is brittle, exhibiting sudden cracking and often collapse. Consequently, a reinforced beam should provide a moment strength in excess of its cracking moment. The amount of this overstrength is somewhat arbitrary, but a factor of 1.3 is required by the *Uniform Building Code*[3]. This means that the moment strength of a cracked-section, RBM beam should exceed 1.3 times the cracking moment of the beam. This is not a requirement of the MSJC Code, but is considered good engineering practice.

## Beam Sizing

In the design of an RBM beam, the required cross-sectional area of masonry is based primarily on the maximum bending moment. However, there are other factors to consider when sizing an RBM beam. For example, it is often desirable to have the width of the RBM beam coincide with the specified wall thickness. RBM beams are sometimes formed with special U-shaped, hollow brick for this reason. These brick may be manufactured specially for this purpose or they may be cut from full-size units at the site. Manufactured special shapes may not be readily available in many localities, so it is best to contact the brick manufacturer as early as possible before proceeding with a design based on their use. The beam’s depth will be determined by the appropriate number of courses of masonry units present. The beam’s depth should be taken as only those courses of solid brick or that are solidly grouted. The beam’s depth may be limited by the height of the wall above an opening. In such cases, compression steel may be necessary when sufficient masonry area is not provided.

## Lateral Bracing

With short spans and relatively deep beams, there is little likelihood of excessive cracking, deflection or rotation. This may not be the case, however, for beams that are relatively long span, shallow or highly loaded. Such beams may be vulnerable to lateral torsional buckling. The designer should consider the lateral bracing conditions to ensure that the beam is laterally braced. The MSJC Code requires that the compression face of beams be laterally supported at a maximum spacing of 32 times the beam thickness. A brick veneer wall is laterally braced by wall ties to the backup system. A RBM beam that is part of a load-bearing wall system may not be laterally braced along its span length. In addition, movement joints at the jambs of a wall opening may result in a lack of lateral bracing for the beam at its supports. In such cases, attachment of the wall to the floor or roof diaphragm is the common means of providing lateral bracing for the beam.

## RBM Arches

Design of RBM arches should begin with an analysis assuming the arch is unreinforced, in accordance with *Technical Notes* 31A or the ARCH computer program available from the Brick Industry Association. Such an analysis will indicate the locations of highest moment and shear, and the horizontal thrust at the abutments. Should the analysis so indicate, the arch should be designed as a reinforced beam. Further, if the conditions shown in Fig. 3 are not met, or if movement joints are provided at the abutments so that the arch may spread under load, the arch should be designed as if it were a straight, simply supported beam as a conservative measure. Alternately, a finite element analysis of the arch may be conducted to determine design moment, shear, and thrust values.

RBM arches cause both a vertical bearing stress and a horizontal thrust on their abutments. The designer has the option of resisting the horizontal thrust of the arch by the abutments or providing room for movement as the RBM arch deforms under load. Judicious placement of vertical expansion joints and flashing will permit horizontal movement and simplify the arch design. This is recommended for longer span arches because providing adequate thrust resistance is difficult and movement joint spacing is limited. In this case, it is very important to provide adequate bearing at the abutments.

## STEEL REINFORCEMENT AND TIES

The quantity of reinforcement required for an RBM beam is typically determined by the applied loads. However, the applicable building code may prescribe a minimum amount of reinforcement and this may dictate the amount of reinforcement required in a RBM beam. For example, all building codes now stipulate a minimum amount of reinforcement for masonry members in areas prone to earthquakes. Some building codes re-

quire that reinforcement in masonry coupling beams be uniformly distributed throughout the beam's height. This may require additional reinforcement and grouting of the masonry above wall openings in RBM beams.

### Bond and Hooks

Typically, reinforcement is inserted in masonry beams to resist tension. The tension must be transferred from the masonry to the reinforcement. This is achieved through adequate bond between the steel reinforcement and the masonry. The bond stress along the length of the reinforcement should not exceed an allowable bond stress of 160 psi (1.1 MPa), according to the MSJC Code Commentary. A minimum embedment length must be provided in order to not exceed this bond stress. Consequently, the MSJC Code stipulates a required bond length for reinforcement in tension, called the minimum embedment length. The minimum embedment length is computed by the following equation:

$$l_d = 0.0015d_b F_s \quad \text{Eq. 2}$$

where:

$l_d$  = embedment length of reinforcement, in. (mm)

$d_b$  = nominal diameter of reinforcement, in. (mm)

$F_s$  = allowable steel stress, psi (MPa)

Table 1 provides the minimum development lengths for various bar and wire sizes, based on Grade 60 ksi (414 MPa) reinforcing bars and 70 ksi (483 MPa) steel wire.

The ends of reinforcing bars and wires may require a standard hook to properly secure the reinforcement and to achieve its strength. In simply-supported beams, the peak moment is often at midspan. For this case, the reinforcement in RBM beams can likely be developed by the bond between the bar or wire and the surrounding masonry with no need for hooks at the ends of the beam. However, a cantilever RBM beam may require a hook at the support end. In addition, shear reinforcement

**TABLE 1**  
**Minimum Development Lengths**

Reinforcement		Minimum Development Length, $l_d$ in. (mm)
Type	No., in. (mm)	
<b>Bars</b> 60 ksi (414 MPa)	3, 0.38 (09.5)	13.5 (343)
	4, 0.50 (12.7)	18.0 (457)
	5, 0.63 (15.9)	22.5 (572)
	6, 0.75 (19.1)	27.0 (686)
	7, 0.88 (22.2)	31.5 (800)
	8, 1.00 (25.4)	36.0 (914)
	9, 1.13 (28.7)	40.6 (1030)
	10, 1.27 (32.3)	45.7 (1160)
	11, 1.41 (35.8)	50.8 (1290)
	<b>Wires</b> 70 ksi (483 MPa)	W1.1, 11 Gage (3.1)
W1.7, 9 Gage (3.8)		6.7 (170)
W2.1, 8 Gage (4.1)		7.3 (185)
W2.8, 0.188 (4.8)		8.3 (214)
W4.9, 0.256 (6.4)		11.3 (286)

ment should always be terminated with a hook. Standard hooks for principal reinforcement may be either a 90 degree or 180 degree turn. Often, the designated space for grout and reinforcement in RBM beams is very small. It can be difficult for a contractor to execute a reinforcement detail properly. Consider that a 180 degree hook doubles the number of bars at a given cross section. The designer should always consider the reinforcement placement, tolerances, and cover restrictions stated in the building codes. *Technical Notes 17A Revised* provides further information on bar sizes, placement requirements and construction tolerances.

### Shear Reinforcement

Where shear reinforcement is required, it should be spaced so that every potential crack is crossed by shear reinforcement. Shear cracks are assumed to be oriented at a 45 degree angle to the longitudinal axis of the RBM beam. This restricts the spacing of shear reinforcement to one-half the beam's effective depth,  $d$ . The spacing of shear reinforcement may be computed by the following equation:

$$s = A_v F_s d / V \quad \text{Eq. 3}$$

where:

$s$  = spacing of shear reinforcement, in. (mm)

$A_v$  = area of shear reinforcement, in.<sup>2</sup> (mm<sup>2</sup>)

$F_s$  = allowable stress for shear reinforcement, psi (MPa)

$d$  = effective depth of beam, in. (mm)

$V$  = design shear force, lb (kg)

When shear reinforcement is required, it should be designed to resist the entire shear force. Shear reinforcement should always be placed parallel to the shear force. For RBM beams the shear reinforcement should be placed vertically. It can be difficult to provide shear reinforcement in RBM beams due to the limited size of grout spaces. This is especially the case with hollow brick units 6 in. (150 mm) or less in thickness and grout spaces between wythes less than approximately 2 in. (50 mm) in width. Consequently, it may be advantageous to increase the beam's depth so that shear reinforcement is not necessary. In fact, this is often the method used by designers to determine the minimum depth of a RBM beam required for a given loading.

### Ties

There are two instances when it may be necessary to include ties in reinforced brick beams. These instances occur only when the beam is formed by grouting between wythes. If the beam has sufficient depth, ties may be required between the wythes. The grout exerts a hydrostatic pressure that must be resisted during construction. The MSJC requires wall ties between wythes as follows:

Wire size W1.7 (3.8 mm), one tie per 2½ ft<sup>2</sup> (0.25 m<sup>2</sup>)

Wire size W2.8 (4.8 mm), one tie per 4½ ft<sup>2</sup> (0.42 m<sup>2</sup>)

Maximum spacing of 36 in. (914 mm) horizontally and 24 in. (610 mm) vertically

Rectangular or Z ties may be used.

In beams that form deep soffits (large beam widths) it may be advisable to tie the soffit brickwork to the grout. Although the grout does bond to the brick, the metal ties

should provide additional capacity and safety. Such ties are placed in the mortar joint and extend into the grout.

## DEFLECTION

Deflection of RBM beams is considered a serviceability issue. Excessive deflection might cause damage to interior finishes, functional problems with doors or windows, and cracking of masonry supported by the beam. The MSJC Code requires that the deflection of RBM beams that support unreinforced or empirically-designed masonry should not exceed the lesser of 0.3 in. (7.6 mm) or span length divided by 600. Deflection of RBM beams may be computed based on uncracked or cracked section properties. Use of uncracked sections results in underestimating the deflection. Deflection based on cracked sections only are over-estimated and are more difficult to calculate. Use of uncracked section is recommended.

Creep is a time-dependent property of brick masonry that will cause the deflection of RBM beams to increase over time. An accurate formula for the estimation of long-term deflections of RBM beams due to creep, that is applicable for all cases and easy to use, does not currently exist. A rule-of-thumb is that the long-term deflection of RBM beams due to creep will be approximately 50 percent greater than their instantaneous deflection. This means that a beam that deflects 1.0 in. (25 mm) when it is fully loaded will creep over time such that its final deflection will be approximately 1.5 in. (38 mm).

## DESIGN CURVES

Maximum efficiency and safety dictate the need for a rational design of all RBM beams according to the applicable building code. However, it is often helpful for the designer to have design aids that can be used to quickly develop a preliminary beam design. The design curves in Figs. 5-9 are provided for that purpose. The size and configuration of masonry and quantity of reinforcement can be quickly determined from these curves based on the span of the beam and the uniform gravity load supported by the beam, including the beam's self-weight. The curves are based on the following assumptions:

1. Compressive strength of masonry is not less than 2000 psi (14 MPa). For most brick masonry, this value will be exceeded. This value was chosen so that beam capacity was not limited by the masonry's compressive strength.
2. Elastic modulus of masonry is not less than 1600 ksi (11030 MPa).
3. The beam is simply supported and subject to uniform gravity loads only.
4. No compression or shear reinforcement is provided.
5. Deflection is calculated on uncracked section properties. The deflection limit of span length divided by 600 does not govern for span lengths less than 14 ft. (4.3 m).

The effective depth,  $d$ , reflected in the design curves is based on the beam height,  $H$ , minus a value for masonry cover. The cover value is based on a reasonable

approximation of brick, mortar and grout cover on the underside of reinforcement for the beams shown. The actual effective depth should always be checked for each particular RBM beam configuration.

## DESIGN EXAMPLE

To illustrate the use of the Design Curves, consider the following example. A RBM beam is to span over a garage door with a clear span of 9 ft (2.7 m). The beam supports its own weight and the weight of the brick masonry wall above the beam, so that the uniform load on the beam is 250 lbs/ft (372 kg/m) of span. The RBM beam and the wall above the beam are nominal 6 in. (150 mm) wide and constructed with hollow brick. Determine the beam depth and reinforcement required for these conditions. From Figs. 5(b) and 5(e), one concludes that a 4 in. (100 mm) or 8 in. (200 mm) high by 6 in. (150 mm) wide RBM beam is not adequate for the given span and loading. Therefore, the applicable Design Curve is Fig. 6(b), which is for a full unit depth, RBM beam. For the given conditions, a minimum depth of 12 in. (300 mm) and one No. 4 bar are required. At this point, any deflection criteria should be considered and may require a greater beam depth.

## SUMMARY

RBM beams are an attractive and efficient means of spanning openings. Attention to detailing of reinforcement and proper design are the key aspects addressed in this *Technical Notes*. The most common RBM beam configurations are shown with consideration of the inter-connection of beam and wall elements. Design curves provided in this *Technical Notes* can be used to develop preliminary beam designs for many different applications and loading conditions.

The information and suggestions contained in this *Technical Notes* are based on the available data and the experience of the engineering staff of the Brick Industry Association. The information contained herein must be used in conjunction with good technical judgment and a basic understanding of the properties of brick masonry. Final decisions on the use of the information contained in this *Technical Notes* are not within the purview of the Brick Industry Association and must rest with the project architect, engineer and owner.

## REFERENCES

1. *Building Code Requirements for Masonry Structures* (ACI 530/ASCE 5/TMS 402-95), American Society of Civil Engineers, Reston, VA, 1996.
2. *Masonry Designers' Guide*, John Matthys, ed., The Masonry Society, Boulder, CO, 1993.
3. *Uniform Building Code*, 1997 Edition, International Conference of Building Officials, Whittier, CA, 1997.



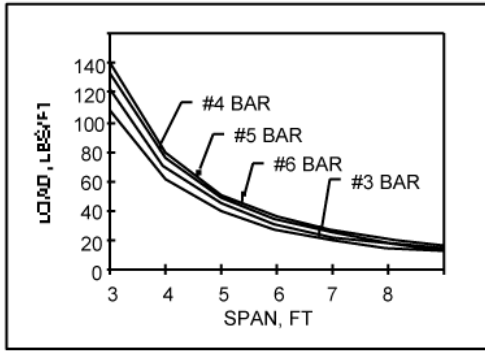

a) H = 4 in. (102 mm)  
W = 5 in. (127 mm)

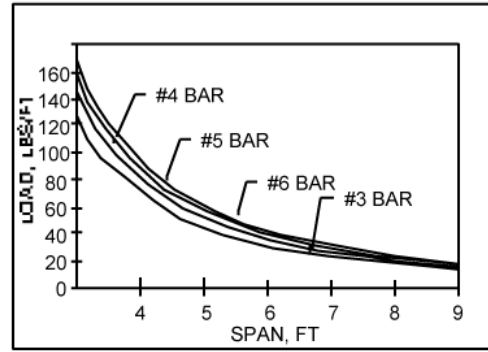

b) H = 4 in. (102 mm)  
W = 6 in. (152 mm)

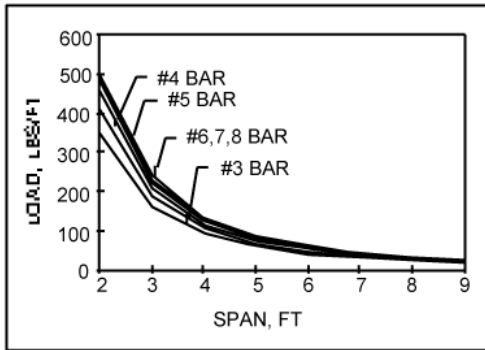

c) H = 4 in. (102 mm)  
W = 8 in. (203 mm)

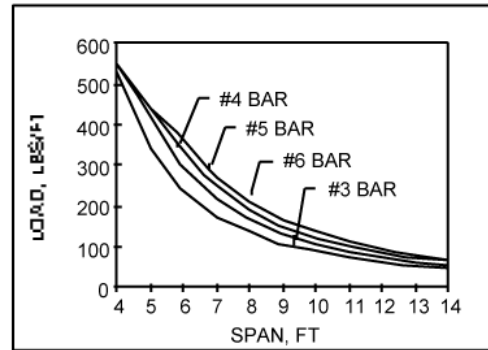

d) H = 8 in. (203 mm)  
W = 5 in. (127 mm)

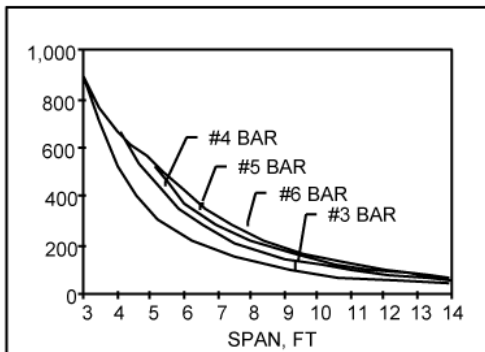

e) H = 8 in. (203 mm)  
W = 6 in. (152 mm)

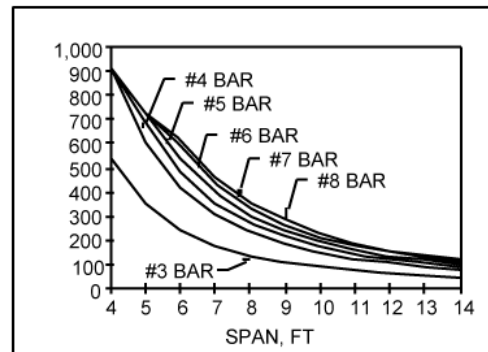

f) H = 8 in. (203 mm)  
W = 8 in. (203 mm)

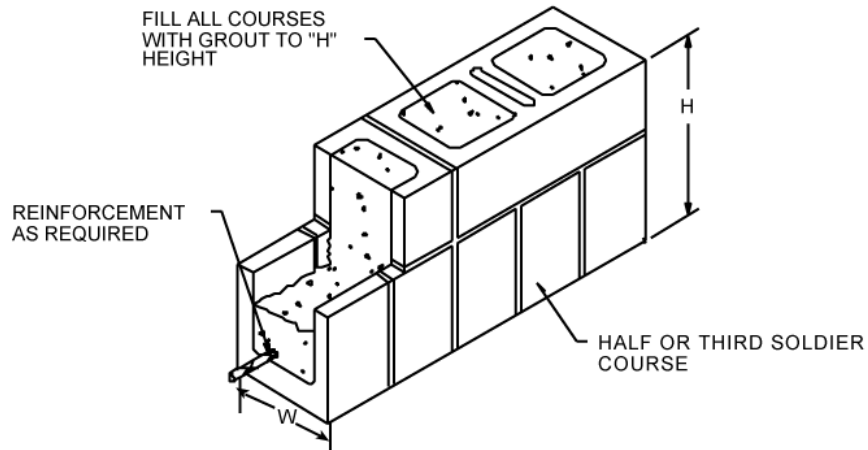

Design Curves for Partial Soldier Course Beams  
FIG. 5

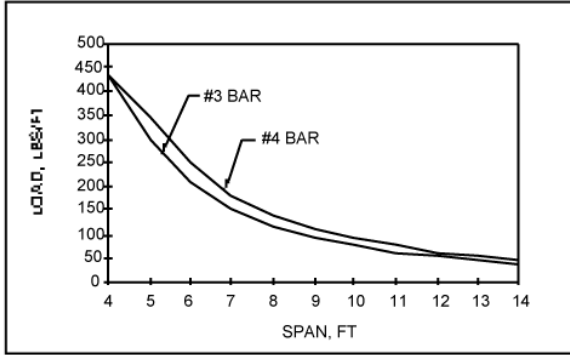

a) H = 8 in. (203 mm)  
W = 4 in. (102 mm)

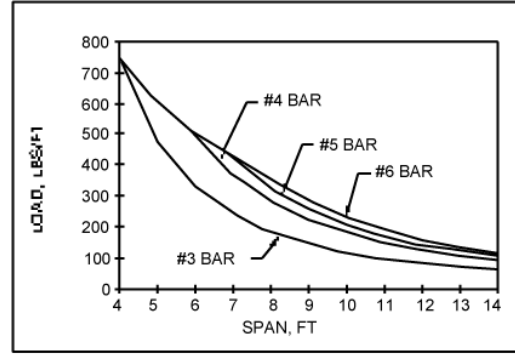

d) H = 10 in. (254 mm)  
W = 5 in. (127 mm)

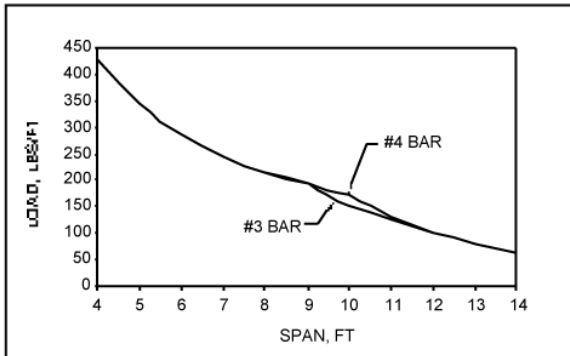

b) H = 12 in. (305 mm)  
W = 4 in. (102 mm)

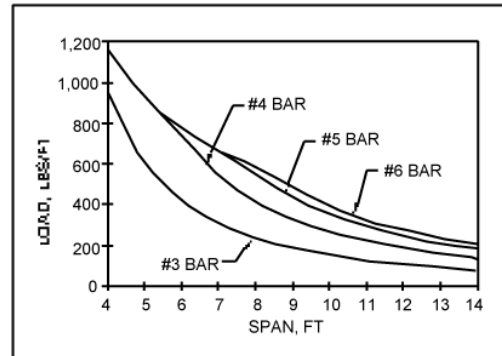

e) H = 12 in. (305 mm)  
W = 6 in. (152 mm)

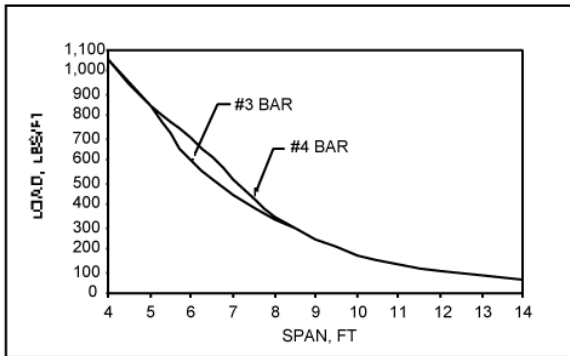

c) H = 16 in. (406 mm)  
W = 4 in. (102 mm)

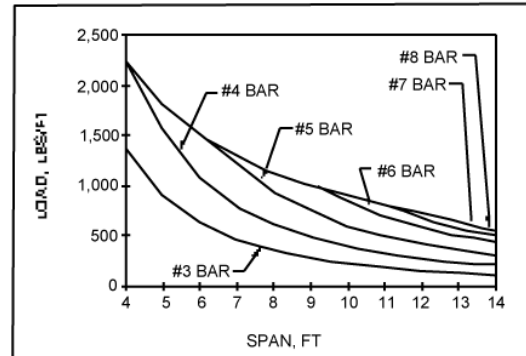

f) H = 16 in. (406 mm)  
W = 8 in. (203 mm)

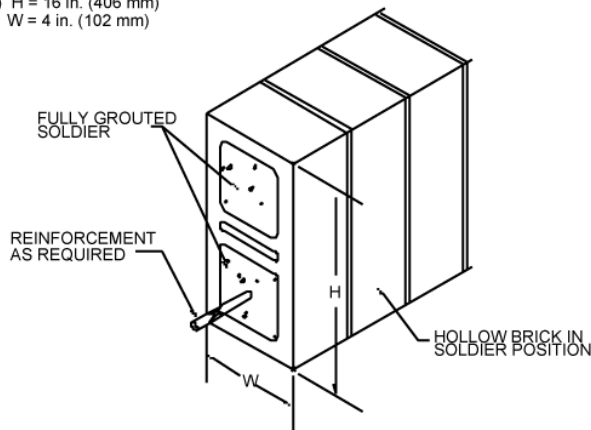

Design Curves for Soldier Course Beams  
FIG. 6



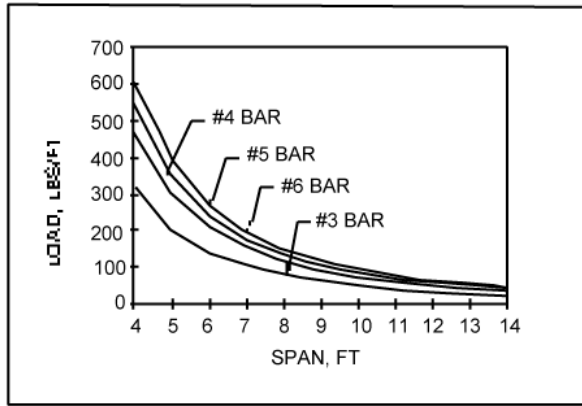

a) H = 8 in. (203 mm)

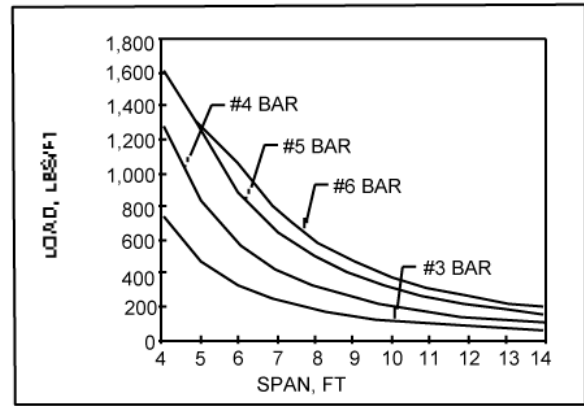

b) H = 12 in. (305 mm)

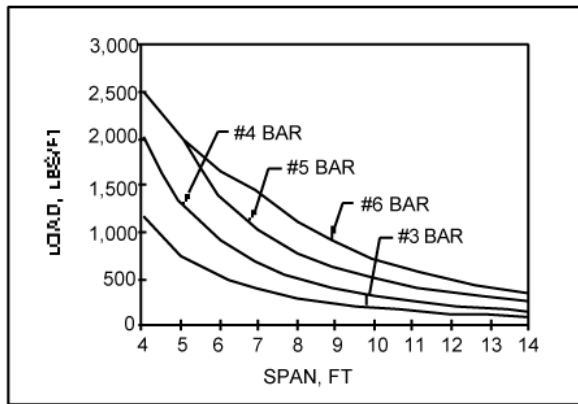

c) H = 16 in. (406 mm)

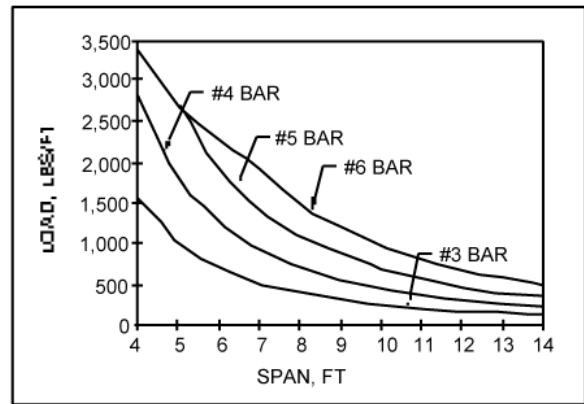

d) H = 20 in. (508 mm)

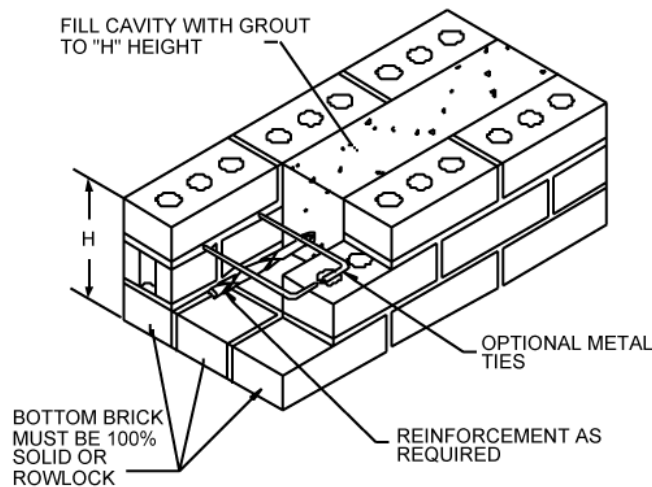

Design Curves for 12 in. (305 mm) Wide Beams  
FIG. 7

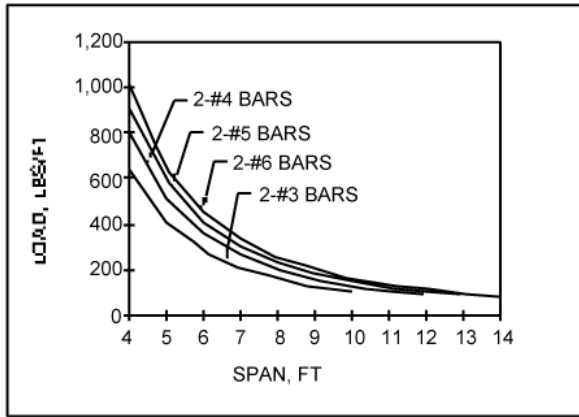

a) H = 8 in. (203 mm)

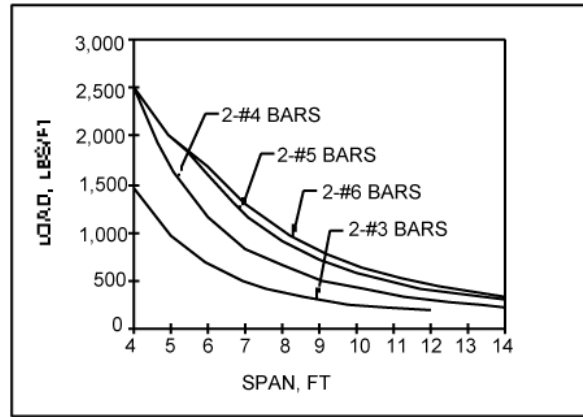

b) H = 12 in. (305 mm)

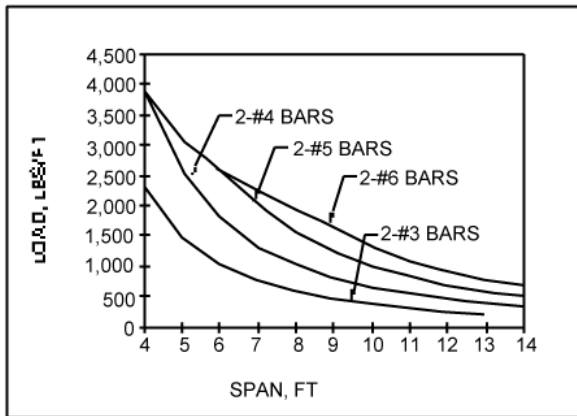

c) H = 16 in. (406 mm)

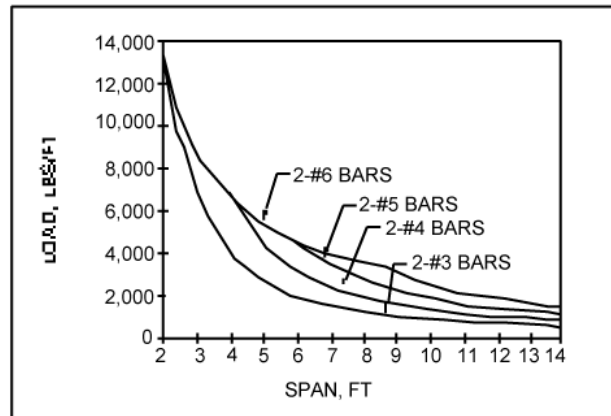

d) H = 24 in. (610 mm)

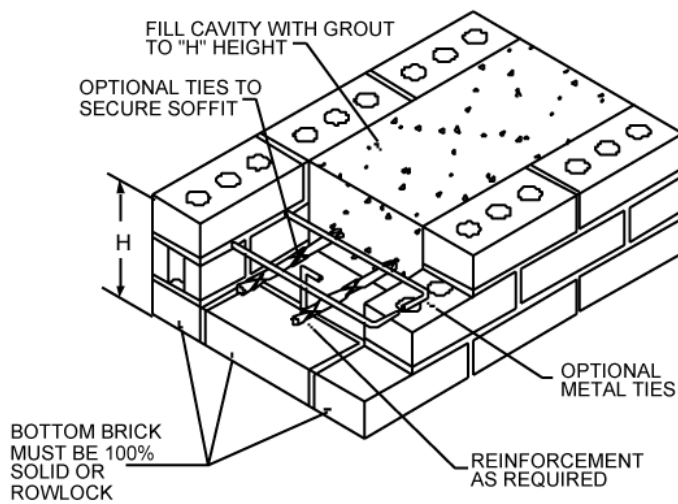

Design Curves for 16 in. (406 mm) Wide Beams  
FIG. 8

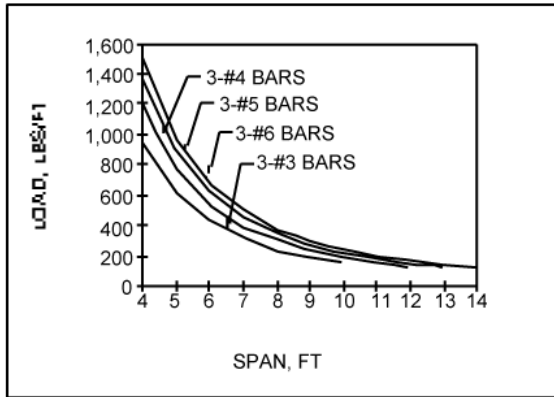

a) H = 8 in. (203 mm)

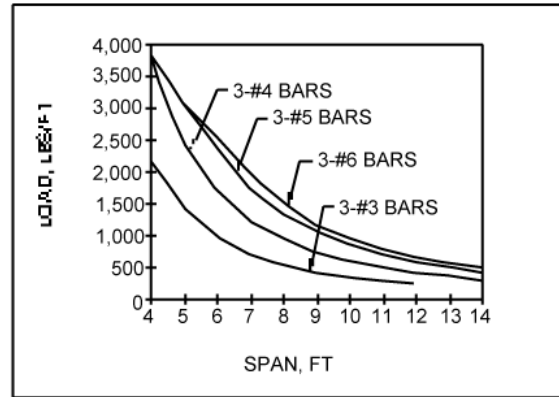

b) H = 12 in. (305 mm)

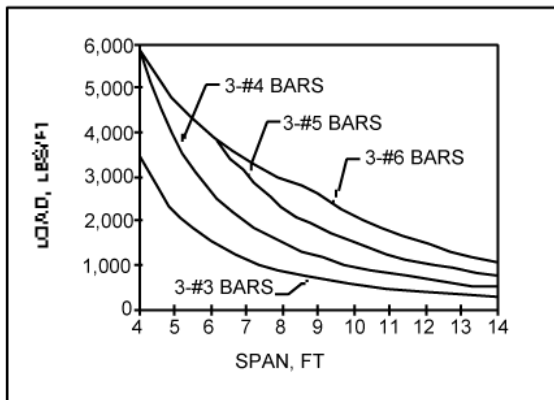

c) H = 16 in. (406 mm)

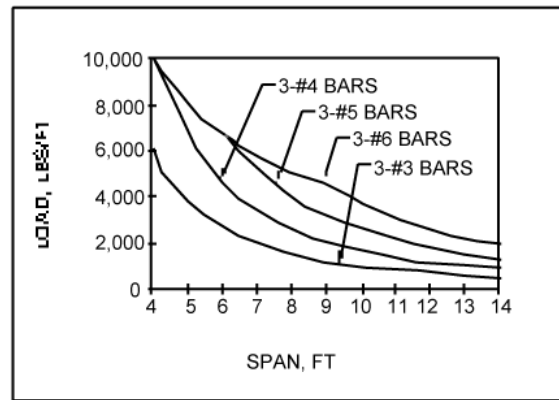

d) H = 24 in. (610 mm)

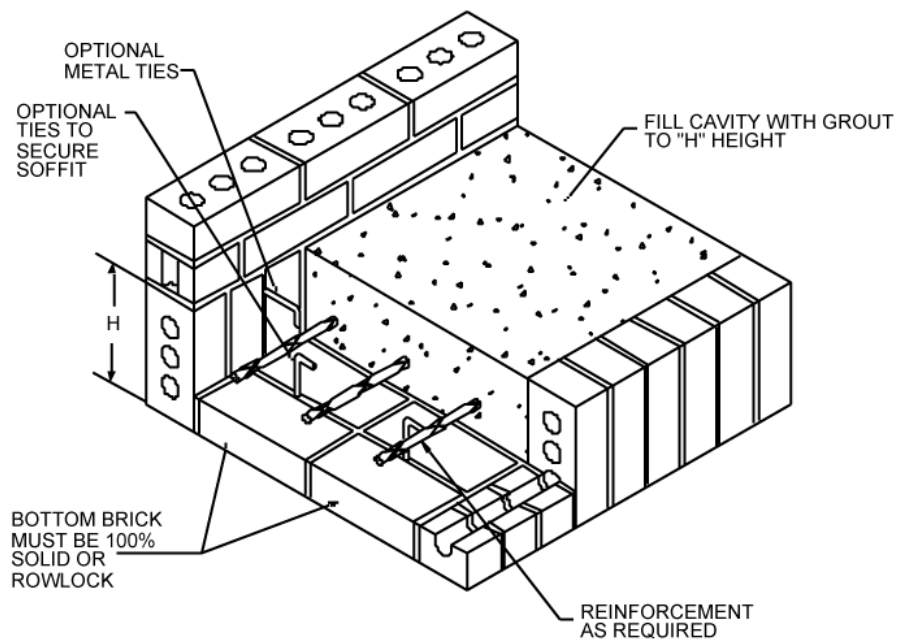

Design Curves for 24 in. (610 mm) Wide Beams  
FIG. 9