

Equilibrium of Rigid Bodies

Notation:

k = spring constant F = name for force vectors, as is P F_x = force component in the x direction F_y = force component in the y direction FBD = free body diagram L = beam span length M = moment due to a force x = horizontal distance	w = name for distributed load W = name for total force due to distributed load α = angle, in a math equation θ = angle, in a trig equation, ex. $\sin\theta$, that is measured between the x axis and <i>tail</i> of a vector Σ = summation symbol
---	--

- *Definition:* Equilibrium is the state when all the external forces acting on a rigid body form a system of forces equivalent to zero. There will be no rotation or translation. The forces are referred to as balanced.

$$R_x = \sum F_x = 0 \quad R_y = \sum F_y = 0 \quad \text{AND} \quad \sum M = 0$$

- It is ABSOLUTELY NECESSARY to consider all the forces acting on a body (applied directly and indirectly) using a FREE BODY DIAGRAM. Omission of a force would ruin the conditions for equilibrium.

FREE BODY DIAGRAM STEPS:

1. Determine the free body of interest. (What body is in equilibrium?)
2. Detach the body from the ground and all other bodies (*“free” it*).
3. Indicate all external forces which include:
 - action on the free body by the **supports & connections**
 - action on the free body by other bodies
 - the weigh effect (=force) of the free body itself (force due to gravity)
4. All forces should be clearly marked with magnitudes and direction. The sense of forces should be those acting *on the body* not by the body.
5. Dimensions/angles should be included for moment computations and force computations.
6. Indicate the unknown angles, distances, forces or moments, such as those reactions or constraining forces where the body is supported or connected. (*Text uses hashes on the unknown forces to distinguish them.*)



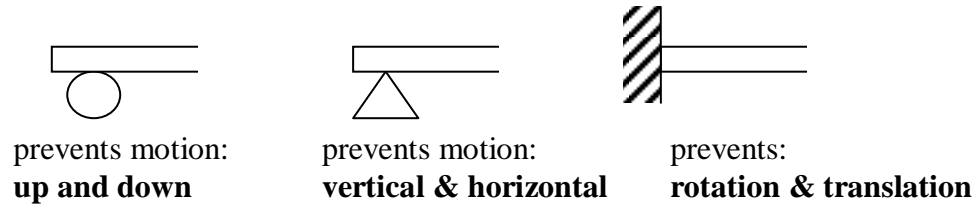







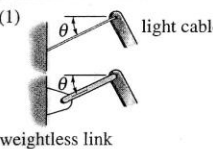
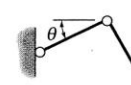
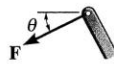
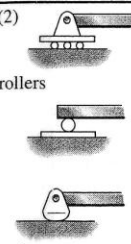
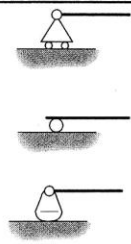
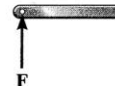

- *Reactions* can be categorized by the type of connections or supports. A reaction is a force with known line of action, or a force of unknown direction, or a moment. The line of action of the force or direction of the moment is directly related to the motion that is prevented.

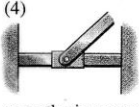
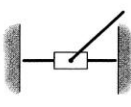

Reactions and Support Connections

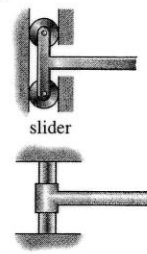
Structural Analysis, 4th ed., R.C. Hibbeler

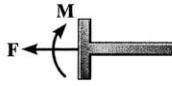
Table 2-1 Supports for Coplanar Structures

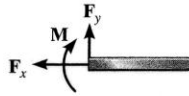
Type of Connection	Idealized Symbol	Reaction	Number of Unknowns
(1)  light cable weightless link			One unknown. The reaction is a force that acts in the direction of the cable or link.
(2)  rollers rocker			One unknown. The reaction is a force that acts perpendicular to the surface at the point of contact.
(3)  smooth contacting surface			One unknown. The reaction is a force that acts perpendicular to the surface at the point of contact.
(4)  smooth pin-connected collar			One unknown. The reaction is a force that acts perpendicular to the surface at the point of contact.
(5)  smooth pin or hinge			Two unknowns. The reactions are two force components.
(6)  slider fixed-connected collar			Two unknowns. The reactions are a force and a moment.
(7)  fixed support			Three unknowns. The reactions are the moment and the two force components.

The line of action should be indicated on the FBD. The sense of direction is determined by the type of support. (Cables are in tension, etc...) *If the sense isn't obvious, assume a sense.* When the reaction value comes out positive, the assumption was correct. When the reaction value comes out negative, the assumption was *opposite* the actual sense. **DON'T CHANGE THE ARROWS ON YOUR FBD OR SIGNS IN YOUR EQUATIONS.**

- With the 3 equations of equilibrium, there can be no more than 3 unknowns. **COUNT THE NUMBER OF UNKNOWN REACTIONS.**

Example 1

(similar to ex. on pg 65)

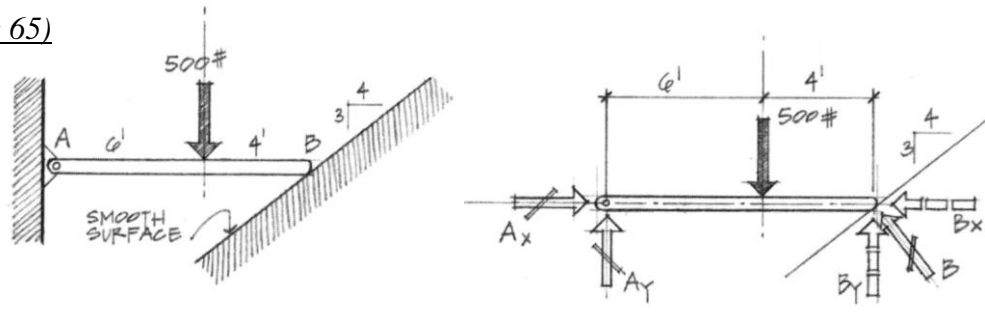

500 lb is known

check:

reactions for the pin-type support at A = A_x & A_y

reactions and components for the smooth surface at B = B (perpendicular to ground only)

equations = 3

procedure:

Write summation of forces in x and y and set = 0.

Choose a place to take a moment. Summing moments at A means that A_x , A_y and B_x have moment arms of zero.

- The general rule is to sum at point where there are the most unknown reactions which usually results in one unknown left in the equation. This “point” could also be where two lines of action intersect.
- More than one moment equation can be used, *but it will not be unique*. Only 3 equations are unique. Variations:

$$\begin{array}{ccc} \sum F_x = 0 & \sum F_y = 0 & \sum M_1 = 0 \quad \text{or} \\ \sum F_x = 0 & \sum M_1 = 0 & \sum M_2 = 0 \quad \text{or} \\ \sum M_1 = 0 & \sum M_2 = 0 & \sum M_3 = 0 \end{array}$$

Recognizing support unknowns in FBD's

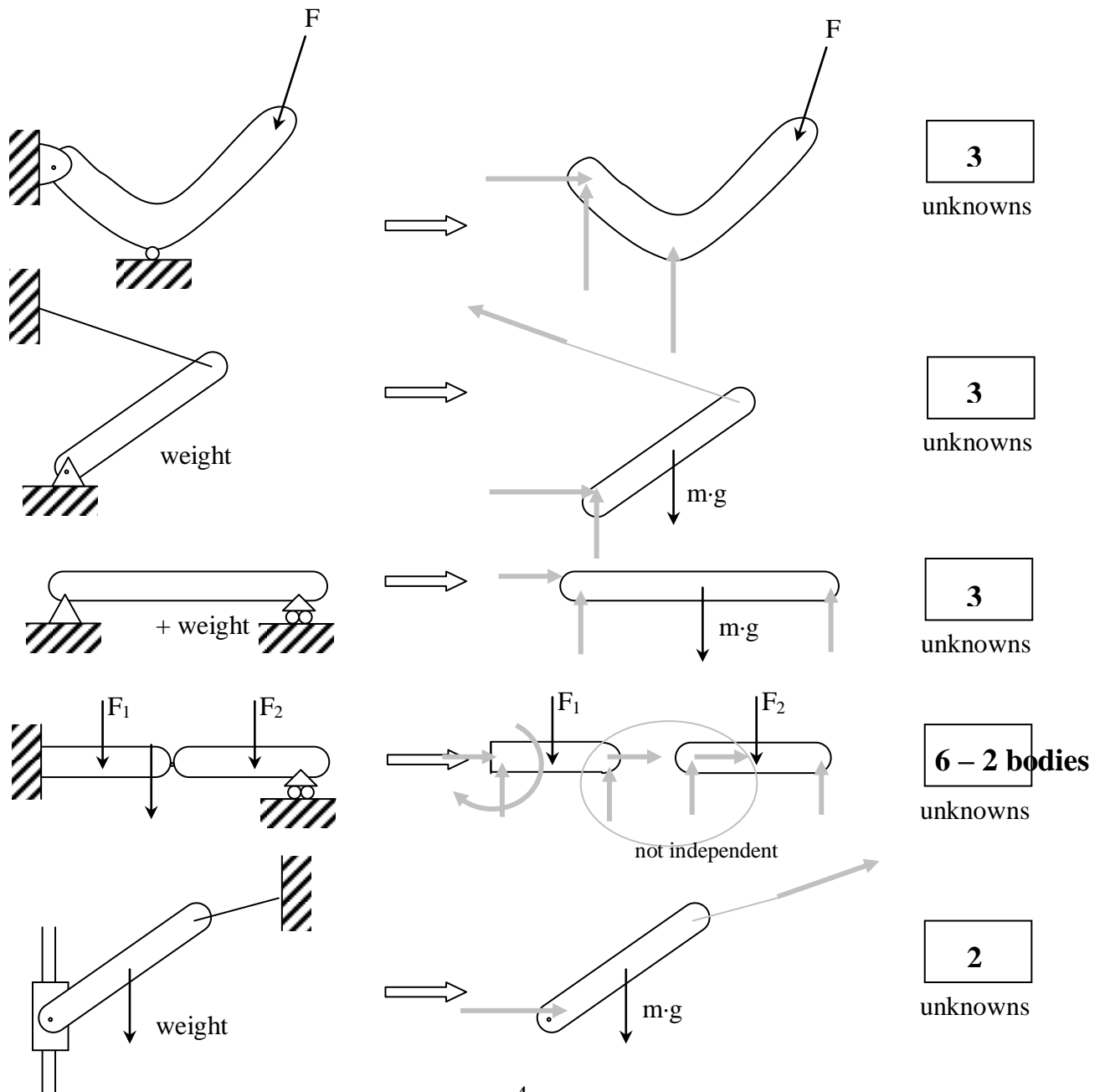

Static Indeterminacy and Improper Constraints

- *Definition:* A completely constrained rigid body has the same number of unknown reactions as number of equilibrium equations and cannot move under the loading conditions. The reactions are statically determinate.
- *Definition:* Statically indeterminate reactions appear on a rigid body when there are more unknown reactions than the number of equilibrium equations. The reactions that cannot be solved for are statically indeterminate. The degree of indeterminacy is the number of additional equations that would be needed to solve, i.e. one more = 1st degree, 2 more = 2nd degree...

Example of Static Indeterminacy:

Find the reactions on the cantilever when a pin is added at C

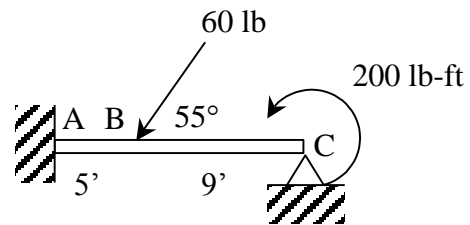
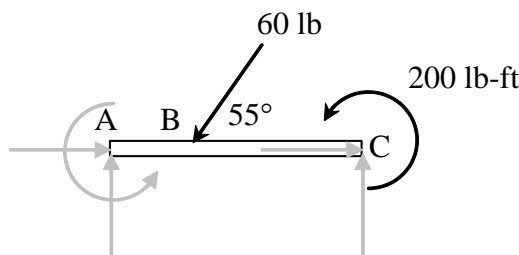

With 5 unknowns, two won't be solvable. (statically indeterminate to the 2nd degree)

- *Definition:* When the support conditions provide the same or less unknown reactions as the equations of equilibrium *but allow the structure to move (not equilibrium)*, the structure is considered partially constrained. This occurs when the reactions must be either **concurrent** or **parallel**.

Example of Partial Constraints:

Find the reactions when the pin support at A changes to a roller

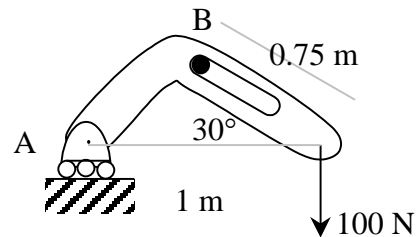
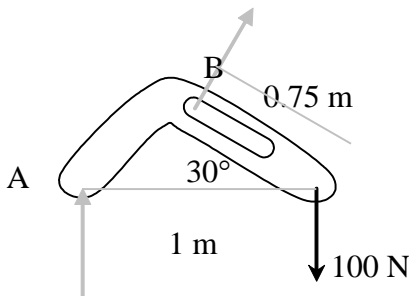

If ΣF_x has to equal 0, the x component must be 0, meaning $B_x = 0$.
 A would have to equal 100 N, but then ΣM wouldn't be 0.

- The condition of at most as many unknown reactions as equilibrium equations is necessary for static determinacy, but isn't sufficient. *The supports must completely constrain the structure.*
- We'd like to avoid partial or improper constraint in the design of our structures. However, some structures with these types of constraints may not collapse. They may move. Or they may require advanced analysis to find reaction forces.

Example of Partial Constraints and Static Indeterminacy:

Find the weight and reactions when the sleeve track is horizontal

$k = 5 \text{ N/mm}$

$k(\Delta l) = F$ by spring

length of unstretched spring = 450 mm

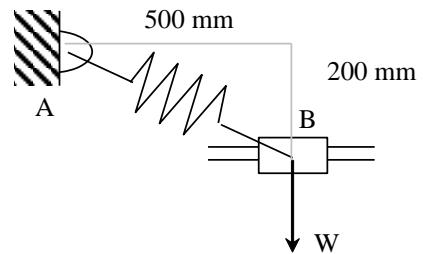

For ΣF to equal 0, the spring force must be 0 (x component = 0) meaning it *can't* be stretched if there is no movement

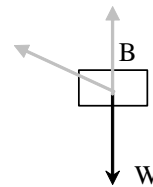

Rigid Body Cases:

1. Two-force body: Equilibrium of a body subjected to two forces on two points requires that those forces be **equal** and **opposite** and act in the same line of action.

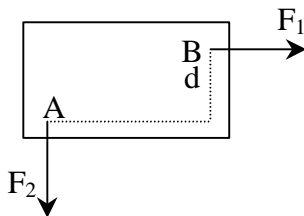

(A)

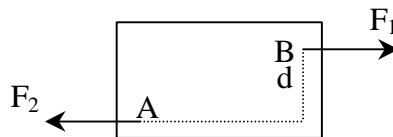

(B)

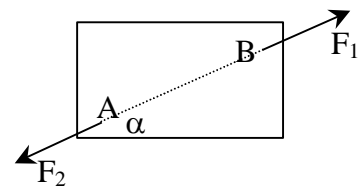

(C)

2. Three-force body: Equilibrium of a body subjected to three forces on three points requires that the line of action of the forces be concurrent (intersect) or parallel AND that the resultant equal zero.

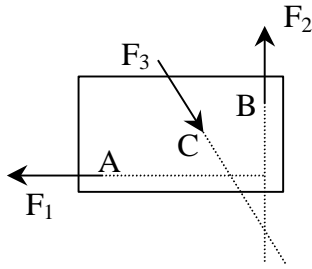

(A) -no

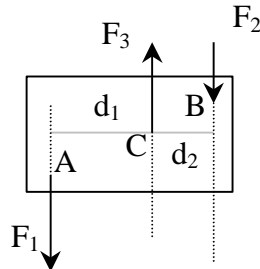

(B)

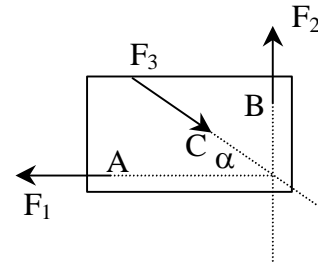

(C)

Loads, Support Conditions & Reactions for Beams

Types of Forces

Concentrated – single load at one point

Distributed – loading spread over a distance or area

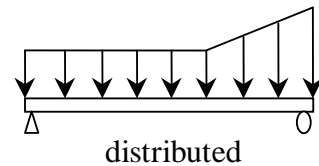
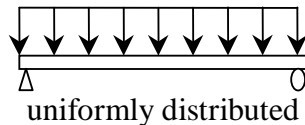
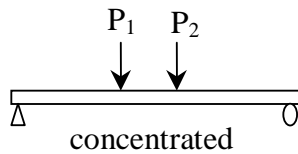

Types of supports:

- Statically determinate
(number of unknowns \leq number of equilibrium equations)

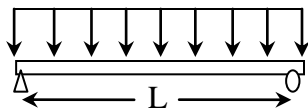

simply supported
(most common)

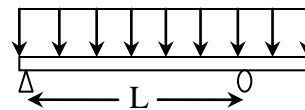

overhang

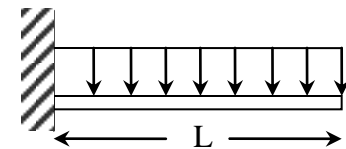

cantilever

- Statically indeterminate: (need more equations from somewhere)

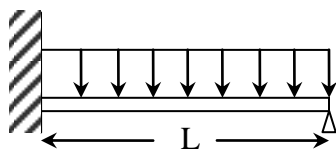

restrained, ex.

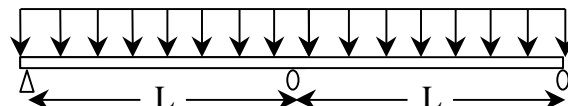

continuous
(most common case when $L_1=L_2$)

Distributed Loads

Distributed loads may be replaced by concentrated loads acting through the balance/center of the distribution or *load area*: THIS IS AN **EQUIVALENT** FORCE SYSTEM.

- w is the symbol used to describe the *load per unit length*.
- W is the symbol used to describe the *total load*.

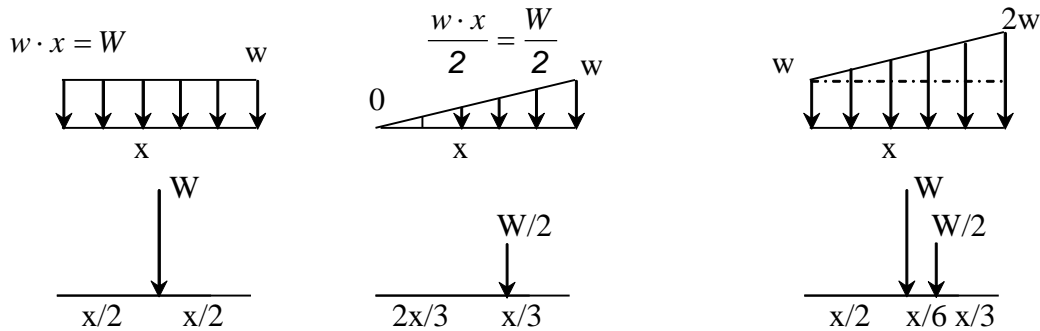

Example 2 (changed from pg 72)

Example Problem 3.14—Cantilever (Figure 3.42)

Determine the support reactions developed at A for a cantilever beam supporting a trapezoidal load and a point load (horizontal) on the bar at the free end.

