

1. SIMPLE BEAM—UNIFORMLY DISTRIBUTED LOAD

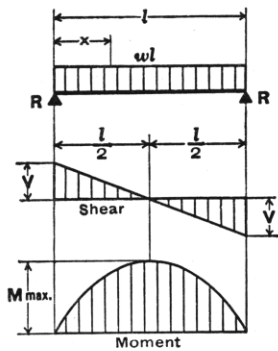

Total Equiv. Uniform Load . . . =  $wl$   
 $R = V$  . . . . . =  $\frac{wl}{2}$   
 $V_x$  . . . . . =  $w \left( \frac{l}{2} - x \right)$   
 $M_{max.}$  ( at center ) . . . . . =  $\frac{wl^2}{8}$   
 $M_x$  . . . . . =  $\frac{wx}{2} (l - x)$   
 $\Delta_{max.}$  ( at center ) . . . . . =  $\frac{5wl^4}{384EI}$   
 $\Delta_x$  . . . . . =  $\frac{wx}{24EI} (l^3 - 2lx^2 + x^3)$

2. SIMPLE BEAM—LOAD INCREASING UNIFORMLY TO ONE END

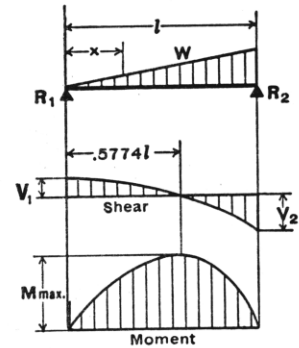

Total Equiv. Uniform Load . . . =  $\frac{16W}{9\sqrt{3}} = 1.0264W$   
 $R_1 = V_1$  . . . . . =  $\frac{W}{3}$        $W = \frac{wl}{2}$   
 $R_2 = V_2$  max. . . . . =  $\frac{2W}{3}$   
 $V_x$  . . . . . =  $\frac{W}{3} - \frac{Wx^2}{l^2}$   
 $M_{max.}$  ( at  $x = \frac{l}{\sqrt{3}} = .5774l$  ) . . . =  $\frac{2Wl}{9\sqrt{3}} = .1283Wl$   
 $M_x$  . . . . . =  $\frac{Wx}{3l^2} (l^2 - x^2)$   
 $\Delta_{max.}$  ( at  $x = l\sqrt{1 - \sqrt{\frac{8}{15}}} = .5193l$  ) =  $.01304 \frac{Wl^3}{EI}$   
 $\Delta_x$  . . . . . =  $\frac{Wx}{180EI l^2} (3x^4 - 10l^2x^2 + 7l^4)$

3. SIMPLE BEAM—LOAD INCREASING UNIFORMLY TO CENTER

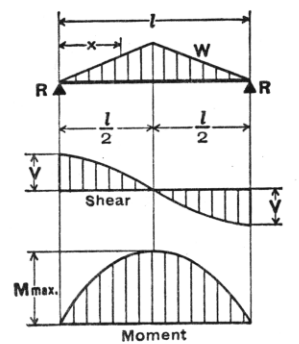

Total Equiv. Uniform Load . . . =  $\frac{4W}{3}$        $W = \frac{wl}{2}$   
 $R = V$  . . . . . =  $\frac{W}{2}$   
 $V_x$  ( when  $x < \frac{l}{2}$  ) . . . . . =  $\frac{W}{2l^2} (l^2 - 4x^2)$   
 $M_{max.}$  ( at center ) . . . . . =  $\frac{Wl}{6}$   
 $M_x$  ( when  $x < \frac{l}{2}$  ) . . . . . =  $Wx \left( \frac{1}{2} - \frac{2x^2}{3l^2} \right)$   
 $\Delta_{max.}$  ( at center ) . . . . . =  $\frac{Wl^3}{60EI}$   
 $\Delta_x$  ( when  $x < \frac{l}{2}$  ) . . . . . =  $\frac{Wx}{480EI l^2} (5l^2 - 4x^2)^2$

4. SIMPLE BEAM—UNIFORM LOAD PARTIALLY DISTRIBUTED

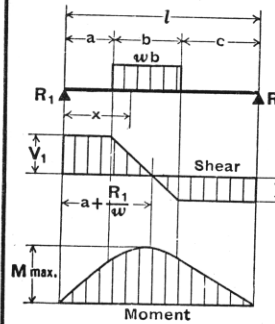

$R_1 = V_1$  ( max. when  $a < c$  ) . . . =  $\frac{wb}{2l} (2c + b)$   
 $R_2 = V_2$  ( max. when  $a > c$  ) . . . =  $\frac{wb}{2l} (2a + b)$   
 $V_x$  ( when  $x > a$  and  $< (a + b)$  ) . =  $R_1 - w(x - a)$   
 $M_{max.}$  ( at  $x = a + \frac{R_1}{w}$  ) . . . . . =  $R_1 \left( a + \frac{R_1}{2w} \right)$   
 $M_x$  ( when  $x < a$  ) . . . . . =  $R_1 x$   
 $M_x$  ( when  $x > a$  and  $< (a + b)$  ) . =  $R_1 x - \frac{w}{2} (x - a)^2$   
 $M_x$  ( when  $x > (a + b)$  ) . . . . . =  $R_2 (l - x)$

5. SIMPLE BEAM—UNIFORM LOAD PARTIALLY DISTRIBUTED AT ONE END

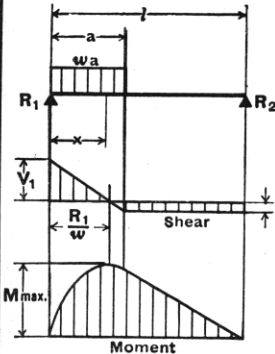

$R_1 = V_1$  max. . . . . =  $\frac{wa}{2l} (2l - a)$   
 $R_2 = V_2$  . . . . . =  $\frac{wa^2}{2l}$   
 $V_x$  ( when  $x < a$  ) . . . . . =  $R_1 - wx$   
 $M_{max.}$  ( at  $x = \frac{R_1}{w}$  ) . . . . . =  $\frac{R_1^2}{2w}$   
 $M_x$  ( when  $x < a$  ) . . . . . =  $R_1 x - \frac{wx^2}{2}$   
 $M_x$  ( when  $x > a$  ) . . . . . =  $R_2 (l - x)$   
 $\Delta_x$  ( when  $x < a$  ) . . . . . =  $\frac{wx}{24EI l} (a^2(2l - a)^2 - 2ax^2(2l - a) + lx^3)$   
 $\Delta_x$  ( when  $x > a$  ) . . . . . =  $\frac{wa^2(l - x)}{24EI l} (4xl - 2x^2 - a^2)$

6. SIMPLE BEAM—UNIFORM LOAD PARTIALLY DISTRIBUTED AT EACH END

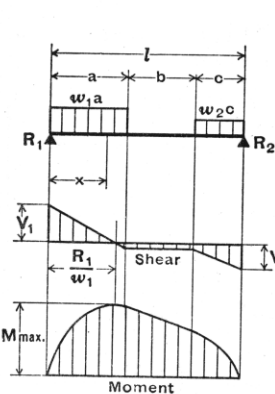

$R_1 = V_1$  . . . . . =  $\frac{w_1 a(2l - a) + w_2 c^2}{2l}$   
 $R_2 = V_2$  . . . . . =  $\frac{w_2 c(2l - c) + w_1 a^2}{2l}$   
 $V_x$  ( when  $x < a$  ) . . . . . =  $R_1 - w_1 x$   
 $V_x$  ( when  $x > a$  and  $< (a + b)$  ) . =  $R_1 - w_1 a$   
 $V_x$  ( when  $x > (a + b)$  ) . . . . . =  $R_2 - w_2 (l - x)$   
 $M_{max.}$  ( at  $x = \frac{R_1}{w_1}$  when  $R_1 < w_1 a$  ) . =  $\frac{R_1^2}{2w_1}$   
 $M_{max.}$  ( at  $x = l - \frac{R_2}{w_2}$  when  $R_2 < w_2 c$  ) =  $\frac{R_2^2}{2w_2}$   
 $M_x$  ( when  $x < a$  ) . . . . . =  $R_1 x - \frac{w_1 x^2}{2}$   
 $M_x$  ( when  $x > a$  and  $< (a + b)$  ) . =  $R_1 x - \frac{w_1 a}{2} (2x - a)$   
 $M_x$  ( when  $x > (a + b)$  ) . . . . . =  $R_2 (l - x) - \frac{w_2 (l - x)^2}{2}$

7. SIMPLE BEAM—CONCENTRATED LOAD AT CENTER

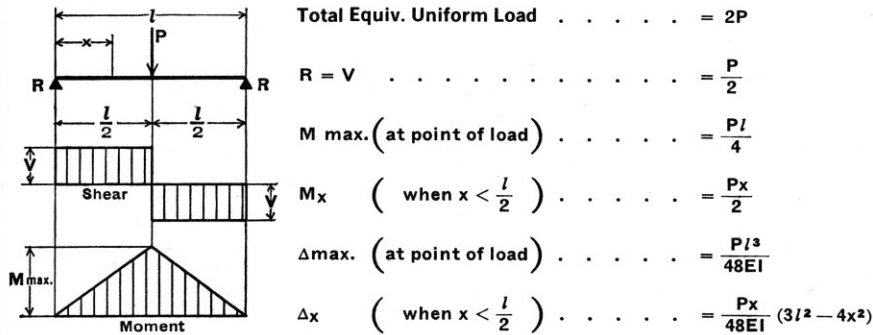

8. SIMPLE BEAM—CONCENTRATED LOAD AT ANY POINT

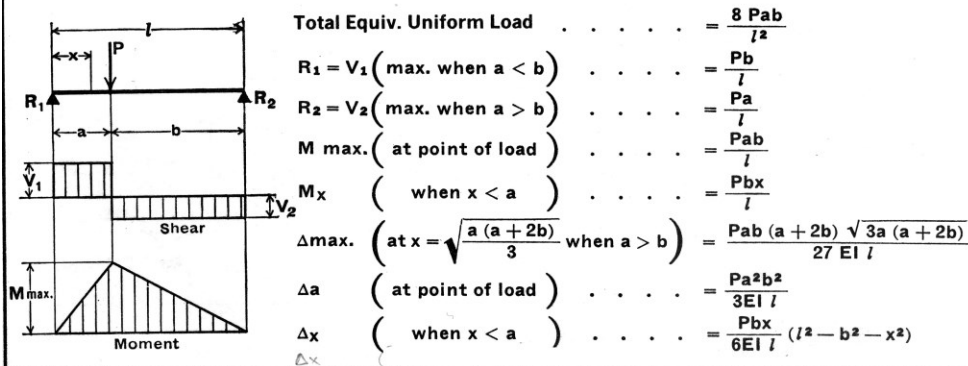

9. SIMPLE BEAM—TWO EQUAL CONCENTRATED LOADS SYMMETRICALLY PLACED

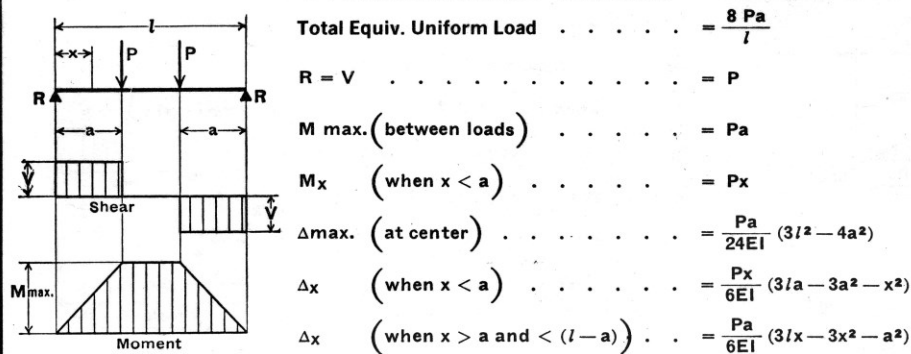

10. SIMPLE BEAM—TWO EQUAL CONCENTRATED LOADS UNSYMMETRICALLY PLACED

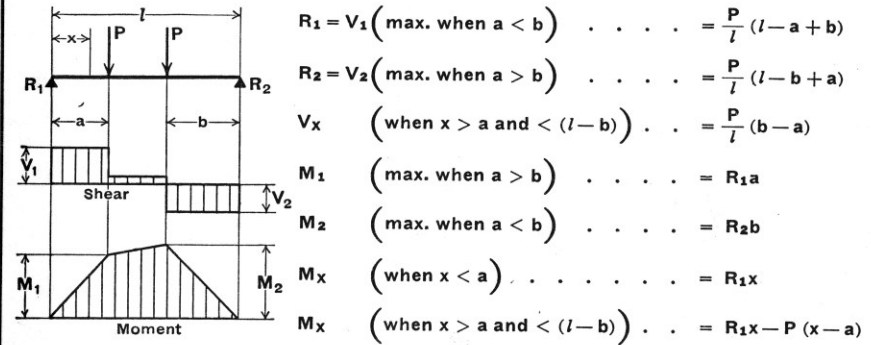

11. SIMPLE BEAM—TWO UNEQUAL CONCENTRATED LOADS UNSYMMETRICALLY PLACED

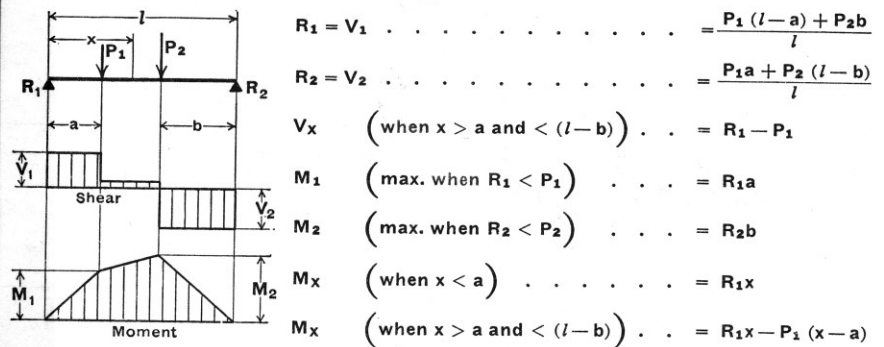

12. BEAM FIXED AT ONE END, SUPPORTED AT OTHER—UNIFORMLY DISTRIBUTED LOAD

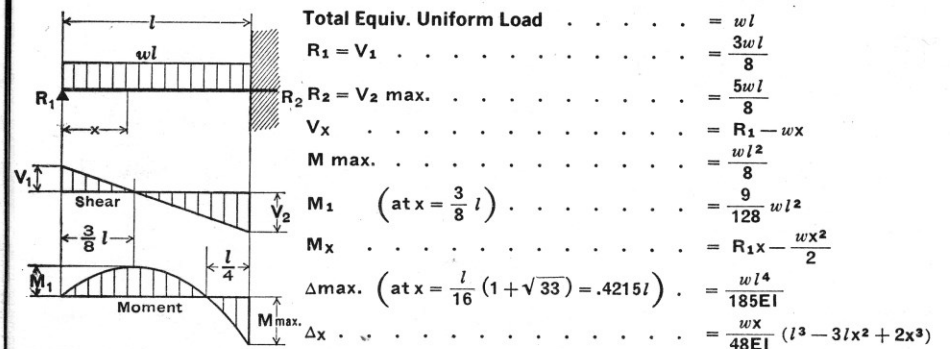

13. BEAM FIXED AT ONE END, SUPPORTED AT OTHER—  
CONCENTRATED LOAD AT CENTER

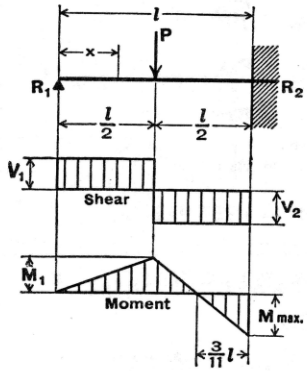

Total Equiv. Uniform Load . . . . . =  $\frac{3P}{2}$   
 $R_1 = V_1$  . . . . . =  $\frac{5P}{16}$   
 $R_2 = V_2$  max. . . . . =  $\frac{11P}{16}$   
 $M$  max. (at fixed end) . . . . . =  $\frac{3Pl}{16}$   
 $M_1$  (at point of load) . . . . . =  $\frac{5Pl}{32}$   
 $M_x$  (when  $x < \frac{l}{2}$ ) . . . . . =  $\frac{5Px}{16}$   
 $M_x$  (when  $x > \frac{l}{2}$ ) . . . . . =  $P \left( \frac{l}{2} - \frac{11x}{16} \right)$   
 $\Delta$  max. (at  $x = l \sqrt{\frac{1}{5}} = .4472l$ ) . . . . . =  $\frac{Pl^3}{48EI \sqrt{5}} = .009317 \frac{Pl^3}{EI}$   
 $\Delta_x$  (at point of load) . . . . . =  $\frac{7Pl^3}{768EI}$   
 $\Delta_x$  (when  $x < \frac{l}{2}$ ) . . . . . =  $\frac{Px}{96EI} (3l^2 - 5x^2)$   
 $\Delta_x$  (when  $x > \frac{l}{2}$ ) . . . . . =  $\frac{P}{96EI} (x-l)^2 (11x - 2l)$

14. BEAM FIXED AT ONE END, SUPPORTED AT OTHER—  
CONCENTRATED LOAD AT ANY POINT

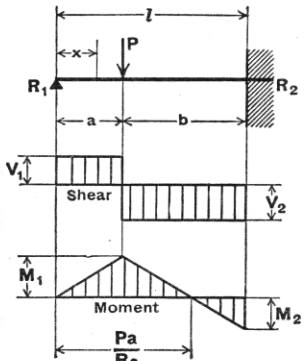

$R_1 = V_1$  . . . . . =  $\frac{Pb^2}{2l^3} (a + 2l)$   
 $R_2 = V_2$  . . . . . =  $\frac{Pa}{2l^3} (3l^2 - a^2)$   
 $M_1$  (at point of load) . . . . . =  $R_1 a$   
 $M_2$  (at fixed end) . . . . . =  $\frac{Pab}{2l^2} (a + l)$   
 $M_x$  (when  $x < a$ ) . . . . . =  $R_1 x$   
 $M_x$  (when  $x > a$ ) . . . . . =  $R_1 x - P(x - a)$   
 $\Delta$  max. (when  $a < .414l$  at  $x = l \frac{l^2 + a^2}{3l^2 - a^2}$ ) =  $\frac{Pa}{3EI} \frac{(l^2 - a^2)^3}{(3l^2 - a^2)^2}$   
 $\Delta$  max. (when  $a > .414l$  at  $x = l \sqrt{\frac{a}{2l+a}}$ ) =  $\frac{Pa^2}{6EI} \sqrt{\frac{a}{2l+a}}$   
 $\Delta_a$  (at point of load) . . . . . =  $\frac{Pa^2 b^3}{12EI l^3} (3l + a)$   
 $\Delta_x$  (when  $x < a$ ) . . . . . =  $\frac{Pb^2 x}{12EI l^3} (3a l^2 - 2l x^2 - a x^2)$   
 $\Delta_x$  (when  $x > a$ ) . . . . . =  $\frac{Pa}{12EI l^3} (l-x)^2 (3l^2 - a^2 x - 2a^2 x)$

15. BEAM FIXED AT BOTH ENDS—UNIFORMLY DISTRIBUTED  
LOADS

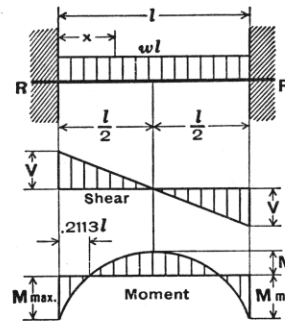

Total Equiv. Uniform Load . . . . . =  $\frac{2wl}{3}$   
 $R = V$  . . . . . =  $\frac{wl}{2}$   
 $V_x$  . . . . . =  $w \left( \frac{l}{2} - x \right)$   
 $M$  max. (at ends) . . . . . =  $\frac{wl^2}{12}$   
 $M_1$  (at center) . . . . . =  $\frac{wl^2}{24}$   
 $M_x$  . . . . . =  $\frac{w}{12} (6lx - l^2 - 6x^2)$   
 $\Delta$  max. (at center) . . . . . =  $\frac{wl^4}{384EI}$   
 $\Delta_x$  . . . . . =  $\frac{wx^2}{24EI} (l-x)^2$

16. BEAM FIXED AT BOTH ENDS—CONCENTRATED LOAD AT  
CENTER

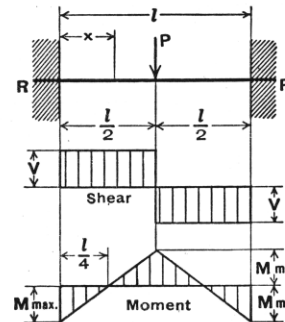

Total Equiv. Uniform Load . . . . . =  $P$   
 $R = V$  . . . . . =  $\frac{P}{2}$   
 $M$  max. (at center and ends) . . . . . =  $\frac{Pl}{8}$   
 $M_x$  (when  $x < \frac{l}{2}$ ) . . . . . =  $\frac{P}{8} (4x - l)$   
 $\Delta$  max. (at center) . . . . . =  $\frac{Pl^3}{192EI}$   
 $\Delta_x$  (when  $x < \frac{l}{2}$ ) . . . . . =  $\frac{Px^2}{48EI} (3l - 4x)$

17. BEAM FIXED AT BOTH ENDS—CONCENTRATED LOAD AT  
ANY POINT

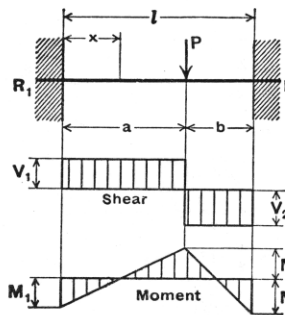

$R_1 = V_1$  (max. when  $a < b$ ) . . . . . =  $\frac{Pb^2}{l^3} (3a + b)$   
 $R_2 = V_2$  (max. when  $a > b$ ) . . . . . =  $\frac{Pa^2}{l^3} (a + 3b)$   
 $M_1$  (max. when  $a < b$ ) . . . . . =  $\frac{Pab^2}{l^2}$   
 $M_2$  (max. when  $a > b$ ) . . . . . =  $\frac{Pa^2 b}{l^2}$   
 $M_a$  (at point of load) . . . . . =  $\frac{2Pa^2 b^2}{l^3}$   
 $M_x$  (when  $x < a$ ) . . . . . =  $R_1 x - \frac{Pab^2}{l^2}$   
 $\Delta$  max. (when  $a > b$  at  $x = \frac{2al}{3a+b}$ ) . . . . . =  $\frac{2Pa^3 b^2}{3EI (3a+b)^2}$   
 $\Delta_a$  (at point of load) . . . . . =  $\frac{Pa^3 b^3}{3EI l^3}$   
 $\Delta_x$  (when  $x < a$ ) . . . . . =  $\frac{Pb^2 x^2}{6EI l^3} (3al - 3ax - bx)$

18. CANTILEVER BEAM—LOAD INCREASING UNIFORMLY TO FIXED END

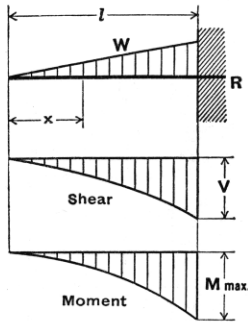

Total Equiv. Uniform Load . . . . . =  $\frac{8}{3} W$   
 $R = V$  . . . . . =  $W$        $W = \frac{wl}{2}$   
 $V_x$  . . . . . =  $W \frac{x^2}{l^2}$   
 $M$  max. (at fixed end) . . . . . =  $\frac{Wl}{3}$   
 $M_x$  . . . . . =  $\frac{Wx^3}{3l^2}$   
 $\Delta$  max. (at free end) . . . . . =  $\frac{Wl^3}{15EI}$   
 $\Delta_x$  . . . . . =  $\frac{W}{60EI l^2} (x^5 - 5l^4x + 4l^5)$

19. CANTILEVER BEAM—UNIFORMLY DISTRIBUTED LOAD

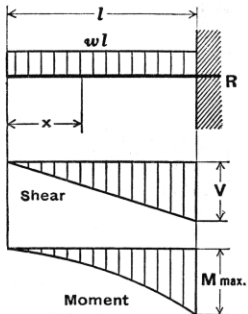

Total Equiv. Uniform Load . . . . . =  $4wl$   
 $R = V$  . . . . . =  $wl$   
 $V_x$  . . . . . =  $wx$   
 $M$  max. (at fixed end) . . . . . =  $\frac{wl^2}{2}$   
 $M_x$  . . . . . =  $\frac{wx^2}{2}$   
 $\Delta$  max. (at free end) . . . . . =  $\frac{wl^4}{8EI}$   
 $\Delta_x$  . . . . . =  $\frac{w}{24EI} (x^4 - 4l^3x + 3l^4)$

20. BEAM FIXED AT ONE END, FREE TO DEFLECT VERTICALLY BUT NOT ROTATE AT OTHER—UNIFORMLY DISTRIBUTED LOAD

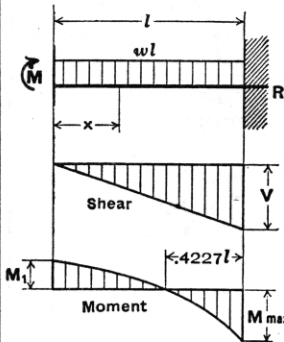

Total Equiv. Uniform Load . . . . . =  $\frac{8}{3} wl$   
 $R = V$  . . . . . =  $wl$   
 $V_x$  . . . . . =  $wx$   
 $M$  max. (at fixed end) . . . . . =  $\frac{wl^2}{3}$   
 $M_1$  (at deflected end) . . . . . =  $\frac{wl^2}{6}$   
 $M_x$  . . . . . =  $\frac{w}{6} (l^2 - 3x^2)$   
 $\Delta$  max. (at deflected end) . . . . . =  $\frac{wl^4}{24EI}$   
 $\Delta_x$  . . . . . =  $\frac{w(l^2 - x^2)^2}{24EI}$

21. CANTILEVER BEAM—CONCENTRATED LOAD AT ANY POINT

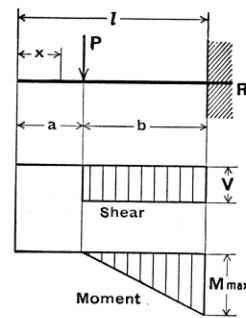

Total Equiv. Uniform Load . . . . . =  $\frac{8Pb}{l}$   
 $R = V$  . . . . . =  $P$   
 $M$  max. (at fixed end) . . . . . =  $Pb$   
 $M_x$  (when  $x > a$ ) . . . . . =  $P(x - a)$   
 $\Delta$  max. (at free end) . . . . . =  $\frac{Pb^2}{6EI} (3l - b)$   
 $\Delta a$  (at point of load) . . . . . =  $\frac{Pb^3}{3EI}$   
 $\Delta_x$  (when  $x < a$ ) . . . . . =  $\frac{Pb^2}{6EI} (3l - 3x - b)$   
 $\Delta_x$  (when  $x > a$ ) . . . . . =  $\frac{P(l - x)^2}{6EI} (3b - l + x)$

22. CANTILEVER BEAM—CONCENTRATED LOAD AT FREE END

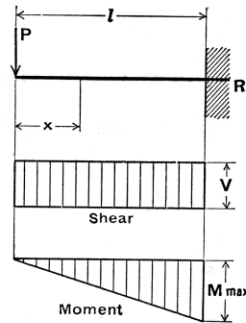

Total Equiv. Uniform Load . . . . . =  $8P$   
 $R = V$  . . . . . =  $P$   
 $M$  max. (at fixed end) . . . . . =  $Pl$   
 $M_x$  . . . . . =  $Px$   
 $\Delta$  max. (at free end) . . . . . =  $\frac{Pl^3}{3EI}$   
 $\Delta_x$  . . . . . =  $\frac{P}{6EI} (2l^3 - 3l^2x + x^3)$

23. BEAM FIXED AT ONE END, FREE TO DEFLECT VERTICALLY BUT NOT ROTATE AT OTHER—CONCENTRATED LOAD AT DEFLECTED END

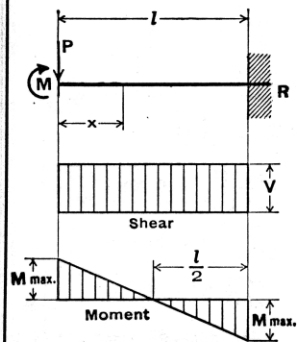

Total Equiv. Uniform Load . . . . . =  $4P$   
 $R = V$  . . . . . =  $P$   
 $M$  max. (at both ends) . . . . . =  $\frac{Pl}{2}$   
 $M_x$  . . . . . =  $P(\frac{l}{2} - x)$   
 $\Delta$  max. (at deflected end) . . . . . =  $\frac{Pl^3}{12EI}$   
 $\Delta_x$  . . . . . =  $\frac{P(l - x)^2}{12EI} (l + 2x)$

**24. BEAM OVERHANGING ONE SUPPORT—UNIFORMLY DISTRIBUTED LOAD**

$R_1 = V_1 \dots = \frac{w}{2l} (l^2 - a^2)$   
 $R_2 = V_2 + V_3 \dots = \frac{w}{2l} (l + a)^2$   
 $V_2 \dots = wa$   
 $V_3 \dots = \frac{w}{2l} (l^2 + a^2)$   
 $V_x \text{ (between supports) } \dots = R_1 - wx$   
 $V_{x_1} \text{ (for overhang) } \dots = w(a - x_1)$   
 $M_1 \text{ (at } x = \frac{l}{2} [1 - \frac{a^2}{l^2}]) \dots = \frac{w}{8l^2} (l + a)^2 (l - a)^2$   
 $M_2 \text{ (at } R_2) \dots = \frac{wa^2}{2}$   
 $M_x \text{ (between supports) } \dots = \frac{wx}{2l} (l^2 - a^2 - xl)$   
 $M_{x_1} \text{ (for overhang) } \dots = \frac{w}{2} (a - x_1)^2$   
 $\Delta_x \text{ (between supports) } \dots = \frac{wx}{24EI} (l^2 - 2lx^2 + lx^3 - 2a^2l^2 + 2a^2x^2)$   
 $\Delta_{x_1} \text{ (for overhang) } \dots = \frac{wx_1}{24EI} (4a^2l - l^3 + 6a^2x_1 - 4ax_1^2 + x_1^3)$

NOTE: For a negative value of  $\Delta_x$ , deflection is upward.

**25. BEAM OVERHANGING ONE SUPPORT—UNIFORMLY DISTRIBUTED LOAD ON OVERHANG**

$R_1 = V_1 \dots = \frac{wa^2}{2l}$   
 $R_2 = V_1 + V_2 \dots = \frac{wa}{2l} (2l + a)$   
 $V_2 \dots = wa$   
 $V_{x_1} \text{ (for overhang) } \dots = w(a - x_1)$   
 $M \text{ max. (at } R_2) \dots = \frac{wa^2}{2}$   
 $M_x \text{ (between supports) } \dots = \frac{wa^2x}{2l}$   
 $M_{x_1} \text{ (for overhang) } \dots = \frac{w}{2} (a - x_1)^2$   
 $\Delta \text{ max. (between supports at } x = \frac{l}{\sqrt{3}}) \dots = \frac{wa^2l^2}{18\sqrt{3}EI} = .03208 \frac{wa^2l^2}{EI}$   
 $\Delta \text{ max. (for overhang at } x_1 = a) \dots = \frac{wa^3}{24EI} (4l + 3a)$   
 $\Delta_x \text{ (between supports) } \dots = \frac{wa^2x}{12EI} (l^2 - x^2)$   
 $\Delta_{x_1} \text{ (for overhang) } \dots = \frac{wx_1}{24EI} (4a^2l + 6a^2x_1 - 4ax_1^2 + x_1^3)$

**26. BEAM OVERHANGING ONE SUPPORT—CONCENTRATED LOAD AT END OF OVERHANG**

$R_1 = V_1 \dots = \frac{Pa}{l}$   
 $R_2 = V_1 + V_2 \dots = \frac{P}{l} (l + a)$   
 $V_2 \dots = P$   
 $M \text{ max. (at } R_2) \dots = Pa$   
 $M_x \text{ (between supports) } \dots = \frac{Pax}{l}$   
 $M_{x_1} \text{ (for overhang) } \dots = P(a - x_1)$   
 $\Delta \text{ max. (between supports at } x = \frac{l}{\sqrt{3}}) \dots = \frac{Pa^2l^2}{9\sqrt{3}EI} = .06415 \frac{Pa^2l^2}{EI}$   
 $\Delta \text{ max. (for overhang at } x_1 = a) \dots = \frac{Pa^2}{3EI} (l + a)$   
 $\Delta_x \text{ (between supports) } \dots = \frac{6EI}{6EI} Pax (l^2 - x^2)$   
 $\Delta_{x_1} \text{ (for overhang) } \dots = \frac{Px_1}{6EI} (2al + 3ax_1 - x_1^2)$

**27. BEAM OVERHANGING ONE SUPPORT—UNIFORMLY DISTRIBUTED LOAD BETWEEN SUPPORTS**

$\text{Total Equiv. Uniform Load} \dots = wl$   
 $R = V \dots = \frac{wl}{2}$   
 $V_x \dots = w(\frac{l}{2} - x)$   
 $M \text{ max. (at center) } \dots = \frac{wl^2}{8}$   
 $M_x \dots = \frac{wx}{2} (l - x)$   
 $\Delta \text{ max. (at center) } \dots = \frac{5wl^4}{384EI}$   
 $\Delta_x \dots = \frac{wx}{24EI} (l^3 - 2lx^2 + x^3)$   
 $\Delta_{x_1} \dots = \frac{wl^3x_1}{24EI}$

**28. BEAM OVERHANGING ONE SUPPORT—CONCENTRATED LOAD AT ANY POINT BETWEEN SUPPORTS**

$\text{Total Equiv. Uniform Load} \dots = \frac{8Pab}{l^2}$   
 $R_1 = V_1 \text{ (max. when } a < b) \dots = \frac{Pb}{l}$   
 $R_2 = V_2 \text{ (max. when } a > b) \dots = \frac{Pa}{l}$   
 $M \text{ max. (at point of load) } \dots = \frac{Pab}{l}$   
 $M_x \text{ (when } x < a) \dots = \frac{Pbx}{l}$   
 $\Delta \text{ max. (at } x = \sqrt{\frac{a(a+2b)}{3}} \text{ when } a > b) \dots = \frac{Pab(a+2b)\sqrt{3a(a+2b)}}{27EI}$   
 $\Delta a \text{ (at point of load) } \dots = \frac{Pa^2b^2}{3EI}$   
 $\Delta_x \text{ (when } x < a) \dots = \frac{Pbx}{6EI} (l^2 - b^2 - x^2)$   
 $\Delta_x \text{ (when } x > a) \dots = \frac{Pa(l-x)}{6EI} (2lx - x^2 - a^2)$   
 $\Delta_{x_1} \dots = \frac{Pabx_1}{6EI} (l + a)$

29. CONTINUOUS BEAM—TWO EQUAL SPANS—UNIFORM LOAD ON ONE SPAN

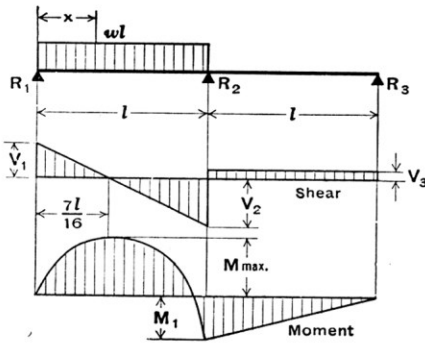

Total Equiv. Uniform Load =  $\frac{49}{64} wl$   
 $R_1 = V_1 = \frac{7}{16} wl$   
 $R_2 = V_2 + V_3 = \frac{5}{8} wl$   
 $R_3 = V_3 = -\frac{1}{16} wl$   
 $V_2 = \frac{9}{16} wl$   
 $M_{max.} \text{ (at } x = \frac{7}{16} l \text{)} = \frac{49}{512} wl^2$   
 $M_1 \text{ (at support } R_2) = \frac{1}{16} wl^2$   
 $M_x \text{ (when } x < l) = \frac{wx}{16} (7l - 8x)$   
 $\Delta_{Max.} \text{ (0.472 } l \text{ from } R_1) = 0.0092 wl^4/EI$

30. CONTINUOUS BEAM—TWO EQUAL SPANS—CONCENTRATED LOAD AT CENTER OF ONE SPAN

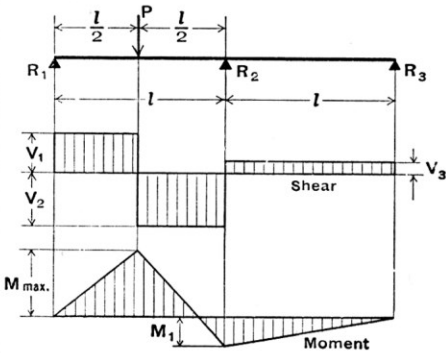

Total Equiv. Uniform Load =  $\frac{13}{8} P$   
 $R_1 = V_1 = \frac{13}{32} P$   
 $R_2 = V_2 + V_3 = \frac{11}{16} P$   
 $R_3 = V_3 = -\frac{3}{32} P$   
 $V_2 = \frac{19}{32} P$   
 $M_{max.} \text{ (at point of load)} = \frac{13}{64} Pl$   
 $M_1 \text{ (at support } R_2) = \frac{3}{32} Pl$   
 $\Delta_{Max.} \text{ (0.480 } l \text{ from } R_1) = 0.015 P l^3/EI$

31. CONTINUOUS BEAM—TWO EQUAL SPANS—CONCENTRATED LOAD AT ANY POINT

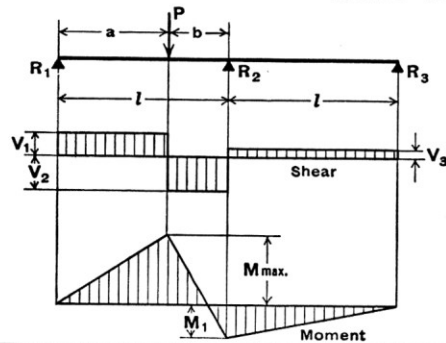

$R_1 = V_1 = \frac{Pb}{4l^3} (4l^2 - a(l+a))$   
 $R_2 = V_2 + V_3 = \frac{Pa}{2l^3} (2l^2 + b(l+a))$   
 $R_3 = V_3 = -\frac{Pab}{4l^3} (l+a)$   
 $V_2 = \frac{Pa}{4l^3} (4l^2 + b(l+a))$   
 $M_{max.} \text{ (at point of load)} = \frac{Pab}{4l^3} (4l^2 - a(l+a))$   
 $M_1 \text{ (at support } R_2) = \frac{Pab}{4l^2} (l+a)$

32. BEAM—UNIFORMLY DISTRIBUTED LOAD AND VARIABLE END MOMENTS

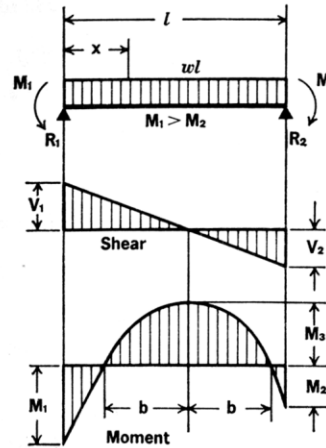

$R_1 = V_1 = \frac{wl}{2} + \frac{M_1 - M_2}{l}$   
 $R_2 = V_2 = \frac{wl}{2} - \frac{M_1 - M_2}{l}$   
 $V_x = w \left( \frac{l}{2} - x \right) + \frac{M_1 - M_2}{l}$   
 $M_3 \text{ (at } x = \frac{l}{2} + \frac{M_1 - M_2}{wl} \text{)}$   
 $= \frac{wl^2}{8} - \frac{M_1 + M_2}{2} + \frac{(M_1 - M_2)^2}{2wl^2}$   
 $M_x = \frac{wx}{2} (l - x) + \left( \frac{M_1 - M_2}{l} \right) x - M_1$

$b \text{ (To locate inflection points)} = \sqrt{\frac{l^2}{4} - \left( \frac{M_1 + M_2}{w} \right) + \left( \frac{M_1 - M_2}{wl} \right)^2}$   
 $\Delta_x = \frac{wx}{24EI} \left[ x^3 - \left( 2l + \frac{4M_1}{wl} - \frac{4M_2}{wl} \right) x^2 + \frac{12M_1}{w} x + l^3 - \frac{8M_1l}{w} - \frac{4M_2l}{w} \right]$

33. BEAM—CONCENTRATED LOAD AT CENTER AND VARIABLE END MOMENTS

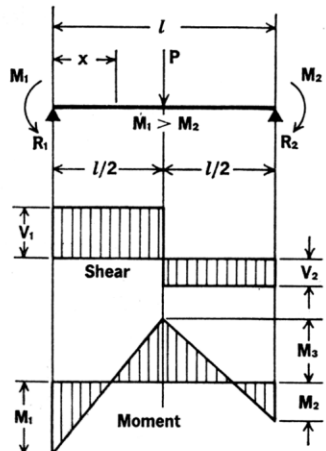

$R_1 = V_1 = \frac{P}{2} + \frac{M_1 - M_2}{l}$   
 $R_2 = V_2 = \frac{P}{2} - \frac{M_1 - M_2}{l}$   
 $M_3 \text{ (At center)} = \frac{Pl}{4} - \frac{M_1 + M_2}{2}$   
 $M_x \text{ (When } x < \frac{l}{2} \text{)} = \left( \frac{P}{2} + \frac{M_1 - M_2}{l} \right) x - M_1$   
 $M_x \text{ (When } x > \frac{l}{2} \text{)} = \frac{P}{2} (l - x) + \frac{(M_1 - M_2)x}{l} - M_1$

$\Delta_x \text{ (When } x < \frac{l}{2} \text{)} = \frac{Px}{48EI} \left( 3l^2 - 4x^2 - \frac{8(l-x)}{Pl} [M_1(2l-x) + M_2(l+x)] \right)$

34. CONTINUOUS BEAM—THREE EQUAL SPANS—ONE END SPAN UNLOADED

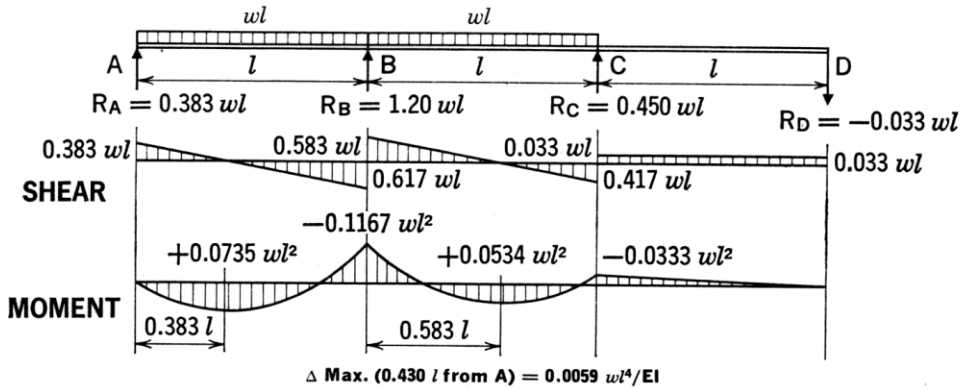

35. CONTINUOUS BEAM—THREE EQUAL SPANS—END SPANS LOADED

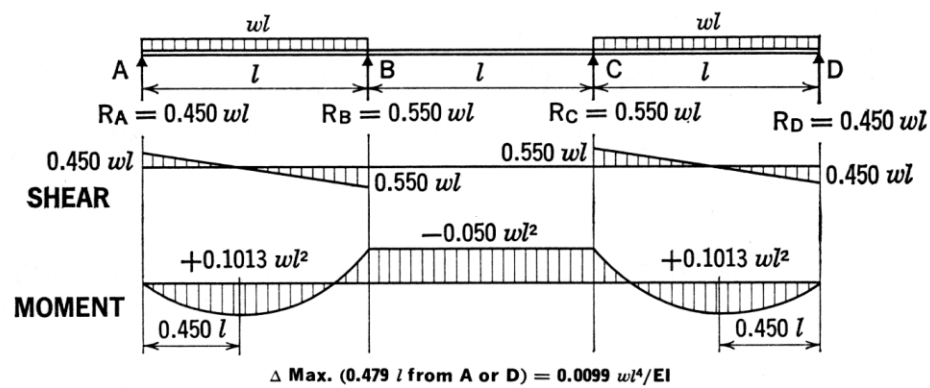

36. CONTINUOUS BEAM—THREE EQUAL SPANS—ALL SPANS LOADED

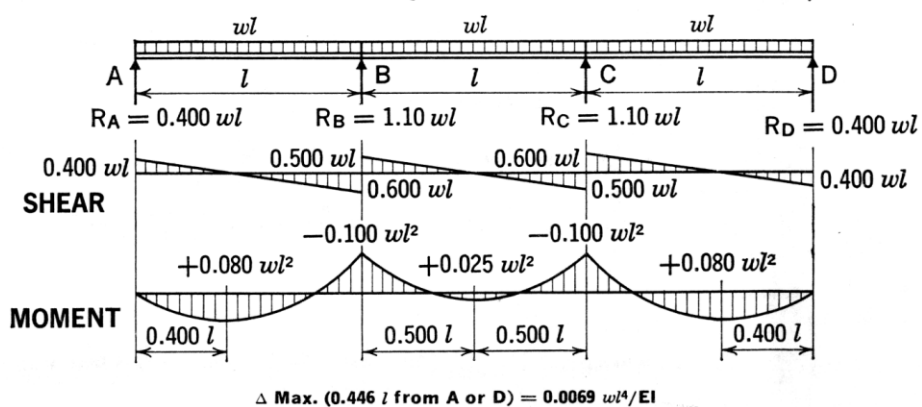

37. CONTINUOUS BEAM—FOUR EQUAL SPANS—THIRD SPAN UNLOADED

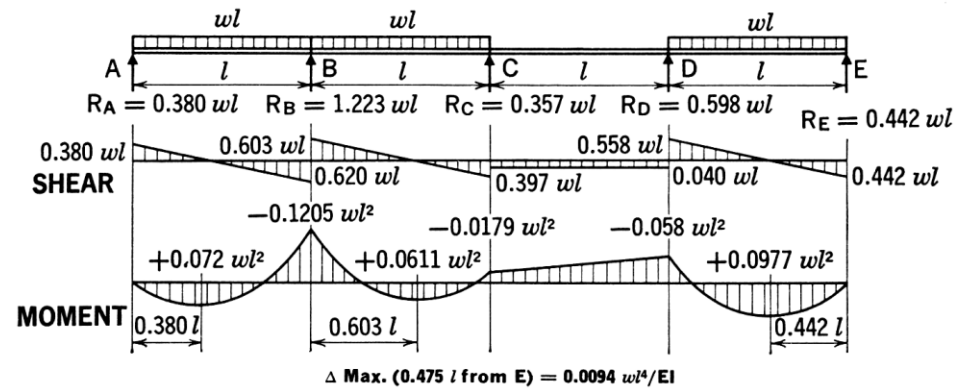

38. CONTINUOUS BEAM—FOUR EQUAL SPANS—LOAD FIRST AND THIRD SPANS

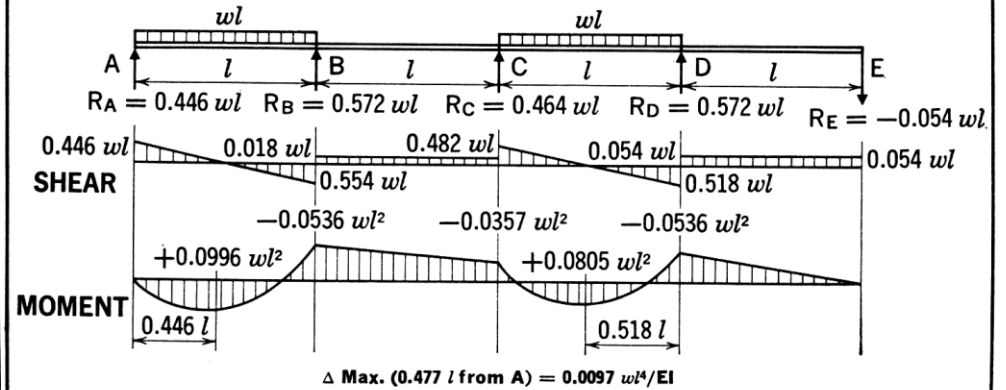

39. CONTINUOUS BEAM—FOUR EQUAL SPANS—ALL SPANS LOADED

